

Dell PowerEdge R570

Technical Guide

Notes, cautions, and warnings

 **NOTE:** A NOTE indicates important information that helps you make better use of your product.

 **CAUTION:** A CAUTION indicates either potential damage to hardware or loss of data and tells you how to avoid the problem.

 **WARNING:** A WARNING indicates a potential for property damage, personal injury, or death.

Chapter 1: PowerEdge R570 system configurations and features.....	5
Key workloads.....	5
New technologies.....	6
Chapter 2: Product comparison.....	8
Chapter 3: Chassis views and features.....	11
System configurations - front view for PowerEdge R570 system.....	11
Left Control Panel (LCP)- Secondary view.....	23
Right Control Panel (RCP) - Primary view.....	25
System configurations - rear view for PowerEdge R570 system.....	26
System configurations - inside view for PowerEdge R570 system.....	30
QR code for PowerEdge R570 system resources.....	32
Chassis configurations.....	32
Chapter 4: Processor.....	33
Processor features.....	33
Supported processors.....	33
Chapter 5: Memory subsystem.....	35
Supported memory.....	35
System memory guidelines.....	35
Chapter 6: Storage.....	38
Storage controllers.....	38
Server storage controllers User Guide.....	38
Supported Drives.....	38
Hard Disk Drives (HDDs).....	39
Internal storage configuration.....	40
External Storage.....	41
Chapter 7: Networking.....	42
Overview.....	42
OCP 3.0 Support.....	42
Supported OCP cards.....	42
OCP NIC 3.0 vs 2.0.....	43
OCP form factors.....	43
Chapter 8: PCIe subsystem.....	44
PCIe risers.....	44
Chapter 9: Power, thermal, and acoustics.....	49
Power.....	49

Power Supply Units.....	49
Thermal.....	51
Thermal design.....	51
Acoustics.....	52
Acoustical configurations of R570	52
Chapter 10: Rack, rails, and cable management.....	55
Rails and cable management information.....	55
Chapter 11: Operating Systems and Virtualization.....	64
Supported operating systems.....	64
Chapter 12: Dell Systems Management.....	65
Integrated Dell Remote Access Controller (iDRAC).....	65
Systems Management software support matrix.....	66
Chapter 13: Appendix A: Additional specifications.....	68
Chassis dimensions	68
System weight.....	69
NIC port specifications.....	69
DPU Specifications.....	70
Video specifications.....	70
USB Ports.....	71
PSU rating.....	72
Environmental specifications.....	73
Particulate and gaseous contamination specifications.....	73
Thermal restriction matrix.....	74
Chapter 14: Appendix B. Standards compliance.....	79
Chapter 15: Appendix C: Additional resources.....	80
Chapter 16: Appendix D: Service and support.....	81
Why attach service contracts.....	81
ProSupport Infrastructure Suite	81
Specialty Support Services.....	83
ProDeploy Infrastructure Suite.....	84
Supplemental Deployment Services	87
Unique Deployment Scenarios.....	88
DAY 2 – Automation Services with Ansible.....	89
Dell Technologies Consulting Services.....	89

PowerEdge R570 system configurations and features

The PowerEdge R570 system is a 2U server that supports:

- One Intel® Xeon® 6 E-core processor with up to 144 cores
- One Intel® Xeon® 6 P-core processor with up to 86 cores with R1S option
- 16 DIMM slots
- Two redundant AC or DC* power supply units
- Up to 12 x 3.5-inch SATA (HDD) RAID drives+ 4 x EDSFF E3.S Gen5 NVMe drives
- Up to 8 x 2.5-inch NVMe (SSD) RAID drives
- Up to 8 x 2.5-inch NVMe (SSD) drives
- Up to 8 x 2.5-inch SATA (HDD/SSD) drives
- Up to 8 x 2.5-inch SATA/Universal (HDD/SSD) drives
- Up to 16 x 2.5-inch SATA (HDD/SSD) RAID drives
- Up to 24 x 2.5-inch SATA (HDD/SSD) drives
- Up to 8 x EDSFF E3.S (hot-aisle) Gen5 NVMe drives
- Up to 8 x EDSFF E3.S (cold-aisle) Gen5 NVMe drives
- Up to 16 x EDSFF E3.S (cold-aisle) Gen5 NVMe drives
- Up to 16 x EDSFF E3.S (hot-aisle) Gen5 NVMe drives
- Up to 32 x EDSFF E3.S (hot-aisle) Gen5 NVMe drives

NOTE: For more information about how to hot swap NVMe PCIe SSD device, see the *Dell Express Flash NVMe PCIe SSD User's Guide* at [Dell Support](#) page > **Browse all products** > **Infrastructure** > **Data Center Infrastructure** > **Storage Adapters & Controllers** > **Dell PowerEdge Express Flash NVMe PCIe SSD** > **Select This Product** > **Documentation** > **Manuals and Documents**.

NOTE: All instances of SATA drives are referred to as drives in this document, unless specified otherwise.

NOTE: The system board is known as the Host Processor Module (HPM) board in this document.

NOTE: This document provides a comprehensive list of product features. However, features marked with an asterisk (*) may not be available at launch but introduced in future updates. Please note that this document does not confirm the availability or release timeline of any feature. For the most accurate and up-to-date information on feature availability, please refer to the product configurator page on [dell.com](#).

CAUTION: Do not install GPUs, network cards, or other PCIe devices on your system that are not validated and tested by Dell. Damage caused by unauthorized and invalidated hardware installation will null and void the system warranty.

Topics:

- [Key workloads](#)
- [New technologies](#)

Key workloads

The Dell PowerEdge R570 offers powerful performance in a purpose-built, cyber resilient, mainstream server. Ideal for:

- Virtualization/Cloud Scale
- Scale-Out Database
- Edge Compute
- High-Performance Compute

- Software-Defined Storage Node

New technologies

The PowerEdge R570 is capable of handling demanding workloads and applications, such as data warehouses, eCommerce, databases, and high-performance computing (HPC).

Table 1. New technologies

Technology	Detailed Description
Intel® Xeon® 6 E-core processor	Core count: Up to 144 core processor
	88 PCIe Gen 5.0 lanes per CPU, PCIe bifurcation x16, x8, x4, x2(Gen5)
	Max TDP: Up to 330 W
Intel® Xeon® 6 P-core processor	Core count: Up to 86 core processor
	136 PCIe Gen 5.0 lanes per CPU, PCIe bifurcation x16, x8, x4, x2(Gen5)
	Max TDP: Up to 350 W
DDR5 Memory	Up to 8 channels per CPU and 16 DIMMs in total
	Supports RDIMM, DDR5 with ECC up to 6400 MT/s.
PCIe Gen	Gen5 @32 GT/s
PCIe Slot	Up to six* PCIe Slots with x16 lanes in total
Flex I/O	Rear I/O with: <ul style="list-style-type: none"> • 1 x Dedicated BMC Ethernet port • 2 x USB 3.1 Type A ports • 1 x VGA
	OCP NIC card 3.0 : 2 slots on the front (for front I/O configuration) 1 slot on the rear (for rear I/O configuration)
	Front I/O with: <ul style="list-style-type: none"> • 1 x USB 2.0 Type - C port • 1 x USB 2.0 Type A port (Optional) • 1 x Mini-DisplayPort (optional) • 1 x DB9 Serial (with front I/O configuration) • 1 x Dedicated BMC Ethernet port (with front I/O configuration)
M-PESTI	Half-duplex protocol between MCU and CPLD, the modular sideband interface as part of the DC-MHS.
Dedicated PERC	PERC 12 <ul style="list-style-type: none"> • H965i DC-MHS Front • H365i DC-MHS Front • H365i adapter • H965i adapter
Power Supplies	Dual New M-CRPS 60 mm PSU
	Platinum/Titanium 800 W AC/HVDC
	Platinum/Titanium 1100 W AC/HVDC
	Titanium 1500 W AC/HVDC

Table 1. New technologies (continued)

Technology	Detailed Description
	Titanium1500 W 277 Vac and HVDC
	Titanium 1800 W AC/HVDC
	1400 W -48v DC

i **NOTE:** Riser Support Guidelines

- Intel Xeon 6 processor P-core R1S processors provide a higher number of PCIe lanes compared to standard Intel® Xeon 6 processor P-core processors.
- On the PowerEdge R570 platform:
 - Risers RC1, RC4, RC6, RC8, RC10, and RC11 support only R1S processors.
 - Risers RC2 and RC9 support both R1S and standard single-processor configurations, depending on the storage configuration requirements.
- Riser compatibility is subject to platform-specific design and lane allocation constraints.
- Select compatible storage configurations to ensure system integrity and optimal performance.

Product comparison

Table 2. Comparison of PowerEdge R570 and R760xs



Feature	PowerEdge R570	PowerEdge R760xs
Processor	<ul style="list-style-type: none"> One Intel® Xeon® 6 E- core Processor with up to 144 cores or One Intel® Xeon® 6 P- core Processor with up to 86 Cores with R1S option 	<ul style="list-style-type: none"> Two 4th Gen Intel® Xeon® Scalable Processors (Sapphire Rapids) with up to 32 cores Two 5th Gen Intel® Xeon® Scalable Processors (Emerald Rapids) with up to 28 cores
Accelerators	Up to 3 x 400 W DW; Up to 4 x 75 W SW accelerators	Up to two single width 75 W accelerators
Memory		
DIMM speed	Up to 6400 MT/s	Up to 5200 MT/s
Memory type	RDIMM	RDIMM
Memory module slots	16 DDR5 DIMM slots	16 DDR5 DIMM slots
	 NOTE: Supports registered ECC DDR5 DIMMs only.	 NOTE: Supports registered ECC DDR4 DIMMs only.
Storage		
Front bays	<ul style="list-style-type: none"> Up to 12 x 3.5-inch SATA (HDD) RAID max 384 TB Up to 8 x 2.5-inch NVMe RAID max 491.52 TB Up to 8 x 2.5-inch NVMe max 491.52 TB Up to 8 x 2.5-inch SATA max 30.72 TB Up to 8 x 2.5-inch SATA/Universal max 491.52 TB Up to 16 x 2.5-inch SATA RAID max 61.44 TB Up to 24 x 2.5-inch SATA max 92.16 TB Up to 8 x EDSFF E3.S (hot-aisle) Gen5 NVMe max 491.52 TB Up to 8 x EDSFF E3.S (cold-aisle) Gen5 NVMe 491.52 TB Up to 16 x EDSFF E3.S (cold-aisle) Gen5 NVMe max 983.04 TB Up to 16 x EDSFF E3.S (hot-aisle) Gen5 NVMe max 983.04 TB Up to 32 x EDSFF E3.S (hot-aisle) Gen5 NVMe max 1966.08 TB 	<ul style="list-style-type: none"> 0 Drive bay Up to 8 x 3.5-inch SAS/SATA (HDD/SSD) max 192 TB Up to 12 x 3.5-inch SAS/SATA (HDD/SSD) max 288 TB Up to 8 x 2.5-inch SAS/SATA/NVMe (HDD/SSD) max 122.88 TB Up to 16 x 2.5-inch SAS/SATA/NVMe (HDD/SSD) max 121.6 TB Up to 16 x 2.5-inch (SAS/SATA) + 8x 2.5-inch (NVMe) (SSD) max 244.48 TB
Rear bays	Up to 4 x EDSFF E3.S Gen5 NVMe max 245.76 TB	Up to 2 x 2.5-inch SAS/SATA/NVMe (HDD/SSD) max 30.72 TB
Storage controllers		
Internal controllers	<ul style="list-style-type: none"> PERC H365i DC-MHS Front 	<ul style="list-style-type: none"> PERC H355

Table 2. Comparison of PowerEdge R570 and R760xs (continued)

Feature	PowerEdge R570	PowerEdge R760xs
	<ul style="list-style-type: none"> PERC H965i DC-MHS Front PERC H365i adapter PERC H965i adapter 	<ul style="list-style-type: none"> PERC H755 PERC H755N HBA465i PERC H965i HBA355i, HBA465i
External controllers	<ul style="list-style-type: none"> HBA 465e PERC H965e 	<ul style="list-style-type: none"> HBA355e, H965e
Software RAID	N/A	S160
Internal boot	<ul style="list-style-type: none"> Boot Optimized Storage Subsystem (BOSS-N1 DC-MHS) M.2 interposer with up to 2 x M.2 NVMe SSDs USB 	<ul style="list-style-type: none"> Boot Optimized Storage Subsystem (BOSS-N1): HWRAID 2 x M.2 SSDs Internal USB
System management	<ul style="list-style-type: none"> iDRAC iDRAC Direct iDRAC RESTful API with Redfish RACADM CLI iDRAC Service Module (iSM) 	<ul style="list-style-type: none"> iDRAC9 iDRAC Direct iDRAC RESTful API with Redfish iDRAC Service Module Quick Sync 2.0 wireless module
Power supply	<ul style="list-style-type: none"> 800 W Platinum/Titanium 100-240 VAC or 240 HVDC, hot swap redundant 1100 W Platinum/Titanium 100-240 VAC or 240 HVDC, hot swap redundant 1400 W -48 VDC, hot swap redundant 1500 W Titanium 100-240 VAC or 240 HVDC, hot swap redundant 1500 W 277 Vac and HVDC Titanium, hot swap redundant 1800 W Titanium 100-240 VAC or 240 HVDC, hot swap redundant 	<ul style="list-style-type: none"> 600 W Platinum 100-240 VAC/ 240 VDC 700 W Titanium 200-240 VAC/240 VDC 800 W Platinum 100-240 VAC/ 240 VDC 1100 W DC/-48-(-60) V 1100 W Titanium 100-240 VAC/ 240 VDC 1400 W Titanium 100-240 VAC/ 240 VDC 1400 W Platinum 100-240 VAC/ 240 VDC 1400 W Titanium 277 VAC/ 366 VDC 1800 W Titanium 200-240 VAC/240 VDC
Ports		
Network options	<ul style="list-style-type: none"> Up to two OCP NIC card 3.0: 2 slots on the front or 1 slot at the rear 	<ul style="list-style-type: none"> 2 x 1 GbE LOM Max 1 OCP 3.0 (optional)
Front ports	<ul style="list-style-type: none"> 1 x USB 2.0 Type - C port (HOST/BMC Direct) 1 x USB 2.0 Type A port (optional LCP KVM) 1 x Mini-DisplayPort (optional LCP KVM) 1 x DB9 Serial (with front I/O configuration) 1 x Dedicated BMC Ethernet port (with front I/O configuration) 	<ul style="list-style-type: none"> 1 x iDRAC Direct (Micro-AB USB) port 1x USB 2.0 1x VGA
Rear ports	<ul style="list-style-type: none"> 1 x Dedicated BMC Ethernet port 2 x USB 3.1 Type A port 1 x VGA 	<ul style="list-style-type: none"> 1 x Dedicated iDRAC Ethernet port 1 x USB 2.0 1 x USB 3.0

Table 2. Comparison of PowerEdge R570 and R760xs (continued)

Feature	PowerEdge R570	PowerEdge R760xs
		<ul style="list-style-type: none"> • 1 x Serial (optional) • 1 x VGA • 2 x Ethernet
Internal ports	1 x USB 3.1 Type A port	1 x USB 3.0 (optional)
Slots		
PCIe	Up to four Gen5 PCIe slots	Up to two Gen5 PCIe slots
Form factor	2U rack server	2U rack server
Dimensions and weight		
Height	86.8 mm (3.42 inches)	86.8 mm (3.42 inches)
Width	482.0 mm (18.98 inches)	482.0 mm (18.98 inches)
Depth	<ul style="list-style-type: none"> • 802.38 mm (31.59 inches) with bezel • 801.49 mm (31.55 inches) without bezel • (Cold aisle/Front I/O Configuration) —814.5 mm (32.06 inches) without bezel <p>NOTE: The front I/O configuration does not support the bezel</p>	<ul style="list-style-type: none"> • 721.62 mm (28.4 inches) – with bezel • 707.78 mm (27.85 inches) – without bezel
Weight	Max 31 kg (68.3 lb)	Max 28.6 kg (63.0 lb)

Chassis views and features

Topics:

- System configurations - front view for PowerEdge R570 system
- System configurations - rear view for PowerEdge R570 system
- System configurations - inside view for PowerEdge R570 system
- QR code for PowerEdge R570 system resources
- Chassis configurations

System configurations - front view for PowerEdge R570 system

Front views of R570

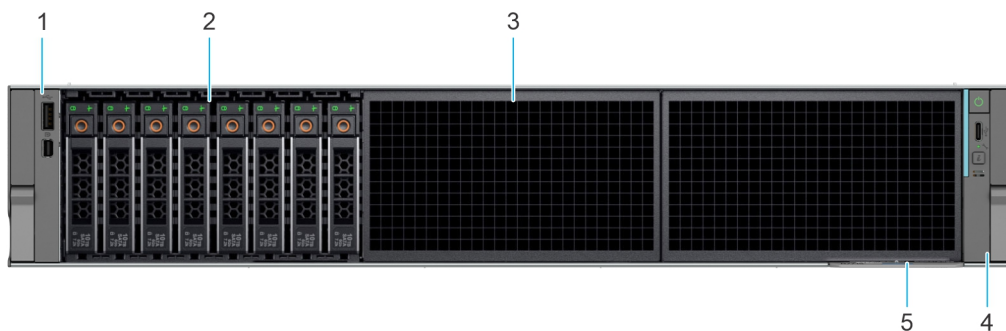

Figure 1. Front view of 8 x 2.5-inch drive system

Table 3. The table shows the list of components in front view of the system.

Item	Ports, panels, and slots	Icon	Description
1	Left control panel (LCP) - Secondary	N/A	<p>Contains the USB 2.0 Type-A port (optional LCP - Secondary KVM) and the Mini DisplayPort (optional LCP - Secondary KVM).</p> <ul style="list-style-type: none"> • USB 2.0 Type-A port (optional LCP - Secondary KVM): This port is USB 2.0-compliant with optional LCP - Secondary KVM functions. • Mini DisplayPort: Enables you to connect a display device to the system. <p>NOTE: Use a certified Mini DisplayPort to DisplayPort cable complying with VESA</p>

Table 3. The table shows the list of components in front view of the system. (continued)

Item	Ports, panels, and slots	Icon	Description
			<p>DisplayPort standards for video output with a monitor.</p> <p>NOTE: Mini DisplayPort to VGA or Mini DisplayPort to HDMI adapters are not recommended.</p>
2	2.5-inch drives	N/A	Enables you to install drives that are supported on your system.
3	Drive blank	Blank	Blank filler for the storage drive slot
4	Right control panel (RCP) - Primary	N/A	Contains the system health LED, system ID, power button, Type-C USB port, and the host status LED.
5	Express Service Tag	N/A	The Express service tag is a slide-out label panel that contains system information such as Service Tag, NIC, MAC address, and so on. If you have opted for the secure default access to iDRAC, the Express service tag also contains the iDRAC secure default password.

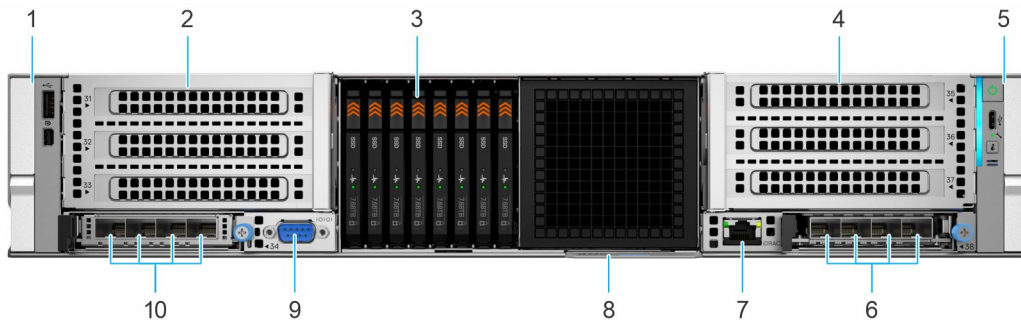

Figure 2. Front view of 8 x EDSFF E3.S NVMe (cold-aisle) drive system

Table 4. The table shows the list of components in front view of the system.

Item	Ports, panels, and slots	Icon	Description
1	Left control panel (LCP) - Secondary	N/A	<p>Contains the USB 2.0 Type-A port (optional LCP - Secondary KVM) and the Mini DisplayPort (optional LCP - Secondary KVM).</p> <ul style="list-style-type: none"> USB 2.0 Type-A port (optional LCP - Secondary KVM): This port is USB 2.0-compliant with

Table 4. The table shows the list of components in front view of the system. (continued)

Item	Ports, panels, and slots	Icon	Description
			<p>optional LCP - Secondary KVM functions.</p> <ul style="list-style-type: none"> Mini DisplayPort: Enables you to connect a display device to the system. <p>i NOTE: Use a certified Mini DisplayPort to DisplayPort cable complying with VESA DisplayPort standards for video output with a monitor.</p> <p>i NOTE: Mini DisplayPort to VGA or Mini DisplayPort to HDMI adapters are not recommended.</p>
2	PCIe front expansion card riser 1	Blank	The expansion card riser enables you to connect PCI Express expansion cards.
3	EDSFF E3.S drives	N/A	Enables you to install drives that are supported on your system.
4	PCIe front expansion card riser 3	Blank	The expansion card riser enables you to connect PCI Express expansion cards.
5	Right control panel (RCP) - Primary	N/A	Contains the system health LED, system ID, power button, Type-C USB port, and the host status LED.
6	OCP NIC (Primary/Secondary) i NOTE: Primary OCP is on slot 38 at the bottom.	N/A	Enables you to install Primary/secondary OCP based on riser configurations .
7	Dedicated iDRAC Ethernet port	N/A	Enables you to access iDRAC port.
8	Drive blank	Blank	Blank filler for the storage drive slot
9	Serial COM port		Enables you to connect a serial device to the system.
10	OCP NIC or BOSS-N1 DC-MHS (Slot 34)	N/A	<p>Enables you to install a secondary OCP or BOSS-N1 DC-MHS controller based on riser configuration.</p> <p>i NOTE: Secondary OCP does not support the shared NIC feature.</p>



Figure 3. Front view of 16 x EDSFF E3.S NVMe (cold-aisle) drive system

Table 5. The table shows the list of components in front view of the system.

Item	Ports, panels, and slots	Icon	Description
1	Left control panel (LCP) - Secondary	N/A	<p>Contains the USB 2.0 Type-A port (optional LCP - Secondary KVM) and the Mini DisplayPort (optional LCP - Secondary KVM).</p> <ul style="list-style-type: none"> • USB 2.0 Type-A port (optional LCP - Secondary KVM): This port is USB 2.0-compliant with optional LCP - Secondary KVM functions. • Mini DisplayPort: Enables you to connect a display device to the system. <p>NOTE: Use a certified Mini DisplayPort to DisplayPort cable complying with VESA DisplayPort standards for video output with a monitor.</p> <p>NOTE: Mini DisplayPort to VGA or Mini DisplayPort to HDMI adapters are not recommended.</p>
2	PCIe front expansion card riser 1	Blank	The expansion card riser enables you to connect PCI Express expansion cards.
3	EDSFF E3.S drives	N/A	Enables you to install drives that are supported on your system.
4	PCIe front expansion card riser 3	Blank	The expansion card riser enables you to connect PCI Express expansion cards.
5	Right control panel (RCP) - Primary	N/A	Contains the system health LED, system ID, power button, Type-C USB port, and the host status LED.

Table 5. The table shows the list of components in front view of the system. (continued)

Item	Ports, panels, and slots	Icon	Description
6	OCP NIC (Primar/Secondary) i NOTE: Primary OCP is on slot 38 at the bottom.	N/A	Enables you to install Primary/secondary OCP based on riser configurations .
7	Dedicated iDRAC Ethernet port	N/A	Enables you to access iDRAC port.
8	EDSFF E3.S drives	N/A	Enables you to install drives that are supported on your system.
9	Serial COM port	IOIOI	Enables you to connect a serial device to the system.
10	OCP NIC or BOSS-N1 DC-MHS (Slot 34)	N/A	Enables you to install a secondary OCP or BOSS-N1 DC-MHS controller based on riser configuration. i NOTE: Secondary OCP does not support the shared NIC feature.

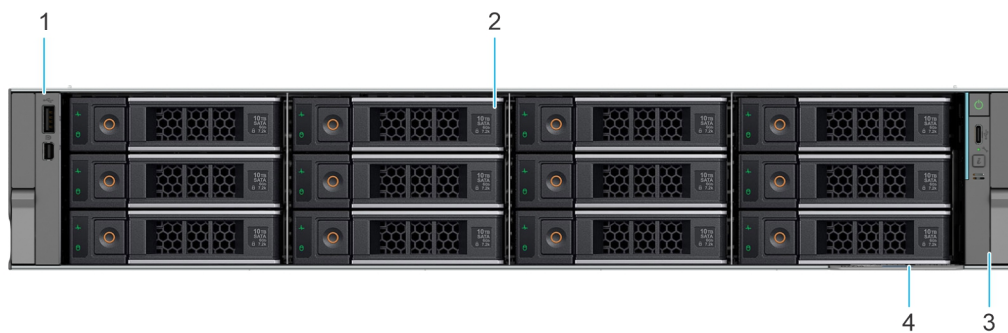

Figure 4. Front view of 12 x 3.5-inch drive system

Table 6. The table shows the list of components in front view of the system.

Item	Ports, panels, and slots	Icon	Description
1	Left control panel (LCP) - Secondary	N/A	Contains the USB 2.0 Type-A port (optional LCP - Secondary KVM) and the Mini DisplayPort (optional LCP - Secondary KVM). <ul style="list-style-type: none"> • USB 2.0 Type-A port (optional LCP - Secondary KVM): This port is USB 2.0-compliant with optional LCP - Secondary KVM functions. • Mini DisplayPort: Enables you to connect a display device to the system. i NOTE: Use a certified Mini DisplayPort to DisplayPort cable complying with VESA DisplayPort standards

Table 6. The table shows the list of components in front view of the system. (continued)

Item	Ports, panels, and slots	Icon	Description
			<p>for video output with a monitor.</p> <p>NOTE: Mini DisplayPort to VGA or Mini DisplayPort to HDMI adapters are not recommended.</p>
2	3.5-inch drives	N/A	Enables you to install drives that are supported on your system.
3	Right control panel (RCP) - Primary	N/A	Contains the system health LED, system ID, power button, Type-C USB port, and the host status LED.
4	Express Service Tag	N/A	The Express service tag is a slide-out label panel that contains system information such as Service Tag, NIC, MAC address, and so on. If you have opted for the secure default access to iDRAC, the Express service tag also contains the iDRAC secure default password.

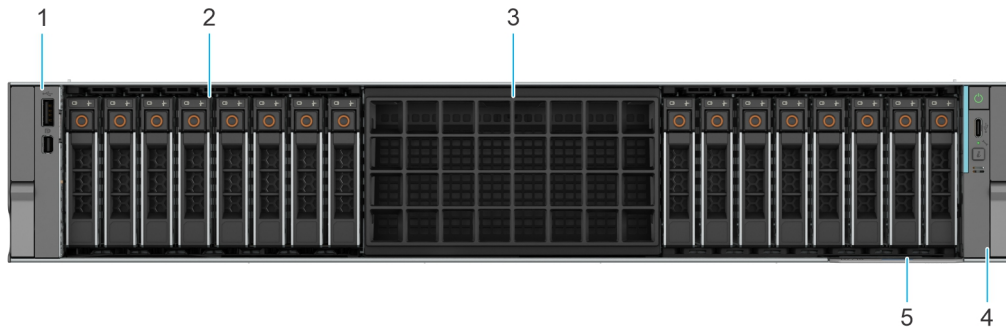

Figure 5. Front view of 16 x 2.5-inch drive system

Table 7. The table shows the list of components in front view of the system.

Item	Ports, panels, and slots	Icon	Description
1	Left control panel (LCP) - Secondary	N/A	<p>Contains the USB 2.0 Type-A port (optional LCP - Secondary KVM) and the Mini DisplayPort (optional LCP - Secondary KVM).</p> <ul style="list-style-type: none"> USB 2.0 Type-A port (optional LCP - Secondary KVM): This port is USB 2.0-compliant with optional LCP - Secondary KVM functions.

Table 7. The table shows the list of components in front view of the system. (continued)

Item	Ports, panels, and slots	Icon	Description
			<ul style="list-style-type: none"> Mini DisplayPort: Enables you to connect a display device to the system. <p>NOTE: Use a certified Mini DisplayPort to DisplayPort cable complying with VESA DisplayPort standards for video output with a monitor.</p> <p>NOTE: Mini DisplayPort to VGA or Mini DisplayPort to HDMI adapters are not recommended.</p>
2	2.5-inch drives	N/A	Enables you to install drives that are supported on your system.
3	Drive blank	Blank	Blank filler for the storage drive slot
4	Right control panel (RCP) - Primary	N/A	Contains the system health LED, system ID, power button, Type-C USB port, and the host status LED.
5	Express Service Tag	N/A	The Express service tag is a slide-out label panel that contains system information such as Service Tag, NIC, MAC address, and so on. If you have opted for the secure default access to iDRAC, the Express service tag also contains the iDRAC secure default password.

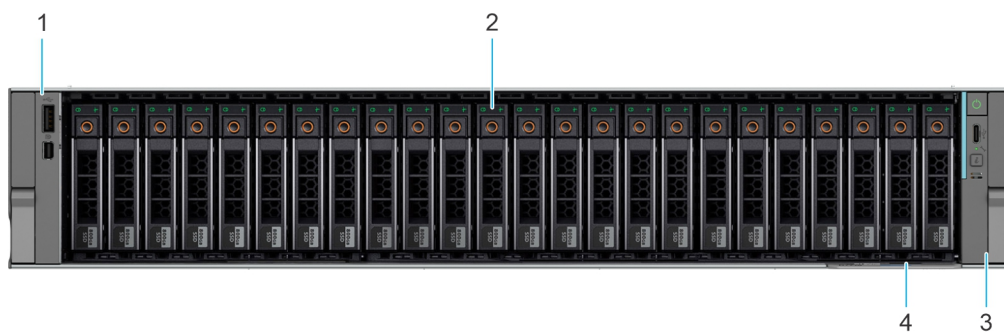

Figure 6. Front view of 24 x 2.5-inch drive system

Table 8. The table shows the list of components in front view of the system.

Item	Ports, panels, and slots	Icon	Description
1	Left control panel (LCP) - Secondary	N/A	<p>Contains the USB 2.0 Type-A port (optional LCP - Secondary KVM) and the Mini DisplayPort (optional LCP - Secondary KVM).</p> <ul style="list-style-type: none"> ● USB 2.0 Type-A port (optional LCP - Secondary KVM): This port is USB 2.0-compliant with optional LCP - Secondary KVM functions. ● Mini DisplayPort: Enables you to connect a display device to the system. <p>NOTE: Use a certified Mini DisplayPort to DisplayPort cable complying with VESA DisplayPort standards for video output with a monitor.</p> <p>NOTE: Mini DisplayPort to VGA or Mini DisplayPort to HDMI adapters are not recommended.</p>
2	2.5-inch drives	N/A	Enables you to install drives that are supported on your system.
3	Right control panel (RCP) - Primary	N/A	Contains the system health LED, system ID, power button, Type-C USB port, and the host status LED.
4	Express Service Tag	N/A	The Express service tag is a slide-out label panel that contains system information such as Service Tag, NIC, MAC address, and so on. If you have opted for the secure default access to iDRAC, the Express service tag also contains the iDRAC secure default password.

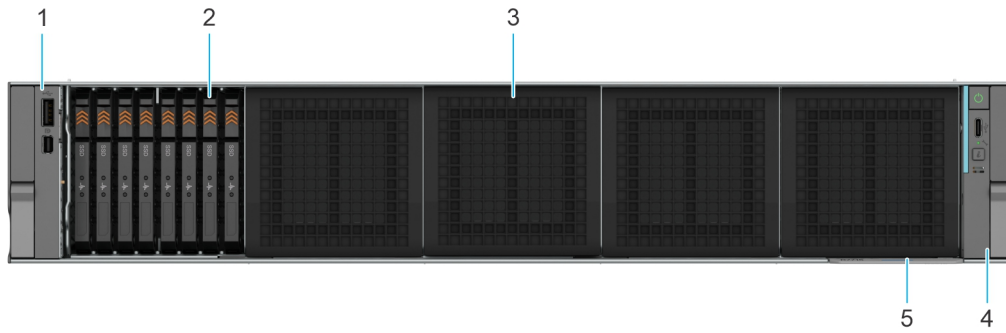

Figure 7. Front view of 8 x EDSFF E3.S NVMe (hot-aisle) drive system

Table 9. The table shows the list of components in front view of the system.

Item	Ports, panels, and slots	Icon	Description
1	Left control panel (LCP) - Secondary	N/A	<p>Contains the USB 2.0 Type-A port (optional LCP - Secondary KVM) and the Mini DisplayPort (optional LCP - Secondary KVM).</p> <ul style="list-style-type: none"> • USB 2.0 Type-A port (optional LCP - Secondary KVM): This port is USB 2.0-compliant with optional LCP - Secondary KVM functions. • Mini DisplayPort: Enables you to connect a display device to the system. <p>NOTE: Use a certified Mini DisplayPort to DisplayPort cable complying with VESA DisplayPort standards for video output with a monitor.</p> <p>NOTE: Mini DisplayPort to VGA or Mini DisplayPort to HDMI adapters are not recommended.</p>
2	EDSFF E3.S drives	N/A	Enables you to install drives that are supported on your system.
3	Drive blank	Blank	Blank filler for the storage drive slot
4	Right control panel (RCP) - Primary	N/A	Contains the system health LED, system ID, power button, Type-C USB port, and the host status LED.
5	Express Service Tag	N/A	The Express service tag is a slide-out label panel that contains system information such as Service Tag, NIC, MAC address, and so on. If

Table 9. The table shows the list of components in front view of the system. (continued)

Item	Ports, panels, and slots	Icon	Description
			you have opted for the secure default access to iDRAC, the Express service tag also contains the iDRAC secure default password.

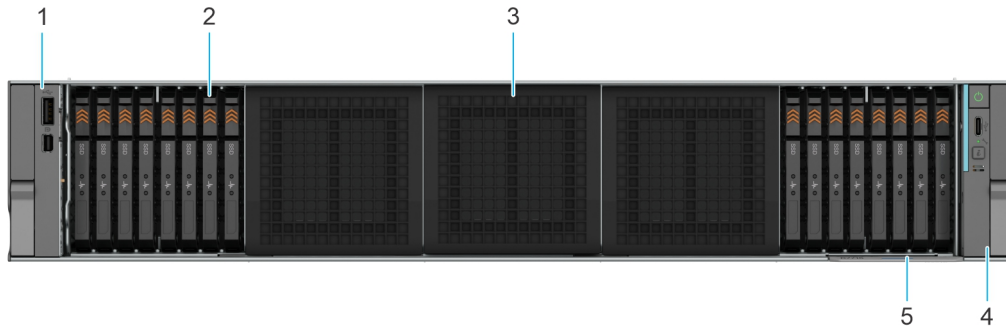

Figure 8. Front view of 16 x EDSFF E3.S NVMe (hot-aisle) drive system

Table 10. The table shows the list of components in front view of the system.

Item	Ports, panels, and slots	Icon	Description
1	Left control panel (LCP) - Secondary	N/A	<p>Contains the USB 2.0 Type-A port (optional LCP - Secondary KVM) and the Mini DisplayPort (optional LCP - Secondary KVM).</p> <ul style="list-style-type: none"> • USB 2.0 Type-A port (optional LCP - Secondary KVM): This port is USB 2.0-compliant with optional LCP - Secondary KVM functions. • Mini DisplayPort: Enables you to connect a display device to the system. <p>NOTE: Use a certified Mini DisplayPort to DisplayPort cable complying with VESA DisplayPort standards for video output with a monitor.</p> <p>NOTE: Mini DisplayPort to VGA or Mini DisplayPort to HDMI adapters are not recommended.</p>
2	EDSFF E3.S drives	N/A	Enables you to install drives that are supported on your system.
3	Drive blank	Blank	Blank filler for the storage drive slot

Table 10. The table shows the list of components in front view of the system. (continued)

Item	Ports, panels, and slots	Icon	Description
4	Right control panel (RCP) - Primary	N/A	Contains the system health LED, system ID, power button, Type-C USB port, and the host status LED.
5	Express Service Tag	N/A	The Express service tag is a slide-out label panel that contains system information such as Service Tag, NIC, MAC address, and so on. If you have opted for the secure default access to iDRAC, the Express service tag also contains the iDRAC secure default password.

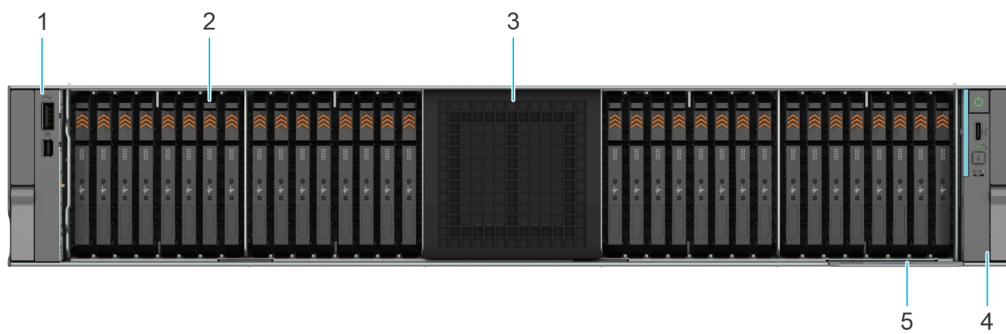

Figure 9. Front view of 32 x EDSFF E3.S NVMe (hot-aisle) drive system

Table 11. The table shows the list of components in front view of the system.

Item	Ports, panels, and slots	Icon	Description
1	Left control panel (LCP) - Secondary	N/A	<p>Contains the USB 2.0 Type-A port (optional LCP - Secondary KVM) and the Mini DisplayPort (optional LCP - Secondary KVM).</p> <ul style="list-style-type: none"> • USB 2.0 Type-A port (optional LCP - Secondary KVM): This port is USB 2.0-compliant with optional LCP - Secondary KVM functions. • Mini DisplayPort: Enables you to connect a display device to the system. <p>NOTE: Use a certified Mini DisplayPort to DisplayPort cable complying with VESA DisplayPort standards for video output with a monitor.</p> <p>NOTE: Mini DisplayPort to VGA or Mini DisplayPort to</p>

Table 11. The table shows the list of components in front view of the system. (continued)

Item	Ports, panels, and slots	Icon	Description
			HDMI adapters are not recommended.
2	EDSFF E3.S drives	N/A	Enables you to install drives that are supported on your system.
3	Drive blank	Blank	Blank filler for the storage drive slot
4	Right control panel (RCP) - Primary	N/A	Contains the system health LED, system ID, power button, Type-C USB port, and the host status LED.
5	Express Service Tag	N/A	The Express service tag is a slide-out label panel that contains system information such as Service Tag, NIC, MAC address, and so on. If you have opted for the secure default access to iDRAC, the Express service tag also contains the iDRAC secure default password.

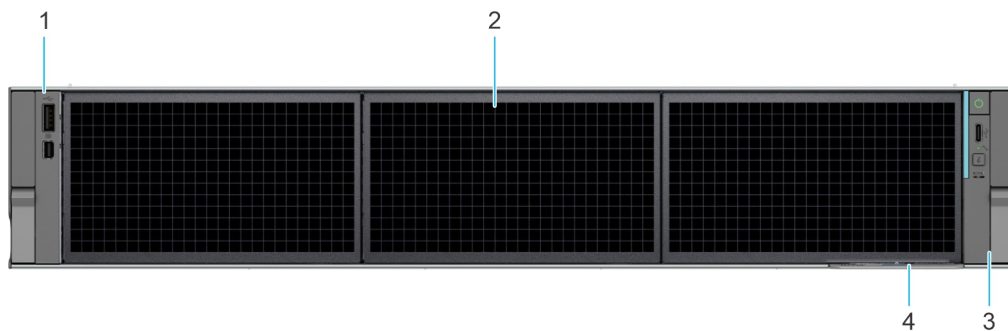

Figure 10. Front view of no backplane configuration system

Table 12. The table shows the list of components in front view of the system.

Item	Ports, panels, and slots	Icon	Description
1	Left control panel (LCP) - Secondary	N/A	<p>Contains the USB 2.0 Type-A port (optional LCP - Secondary KVM) and the Mini DisplayPort (optional LCP - Secondary KVM).</p> <ul style="list-style-type: none"> • USB 2.0 Type-A port (optional LCP - Secondary KVM): This port is USB 2.0-compliant with optional LCP - Secondary KVM functions. • Mini DisplayPort: Enables you to connect a display device to the system. <p>NOTE: Use a certified Mini DisplayPort to</p>

Table 12. The table shows the list of components in front view of the system. (continued)

Item	Ports, panels, and slots	Icon	Description
			<p>DisplayPort cable complying with VESA DisplayPort standards for video output with a monitor.</p> <p>i NOTE: Mini DisplayPort to VGA or Mini DisplayPort to HDMI adapters are not recommended.</p>
2	Drive blank	Blank	Blank filler for the storage drive slot
3	Right control panel (RCP) - Primary	N/A	Contains the system health LED, system ID, power button, Type-C USB port, and the host status LED.
4	Express Service Tag	N/A	The Express service tag is a slide-out label panel that contains system information such as Service Tag, NIC, MAC address, and so on. If you have opted for the secure default access to iDRAC, the Express service tag also contains the iDRAC secure default password.

Left Control Panel (LCP)- Secondary view

The R570 system has three options for Left Control Panel (LCP)- Secondary panel as shown below. The default option is the blank.



Figure 11. Left Control Panel (LCP)- Secondary panel - blank module

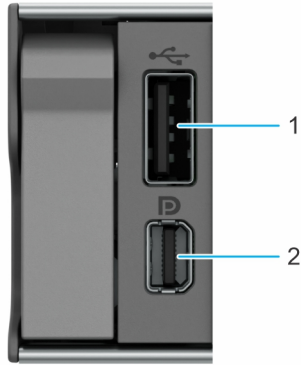



Figure 12. Left Control Panel (LCP)- Secondary panel - KVM module

Table 13. Left Control Panel (LCP)- Secondary panel - KVM module (optional)

Item	Indicator, button, or connector	Icon	Description
1	USB 2.0-compliant port		The USB port is 4-pin, 2.0-compliant. This port enables you to connect USB devices to the system.
2	Mini-Displayport		Enables you to connect a display device to the system.

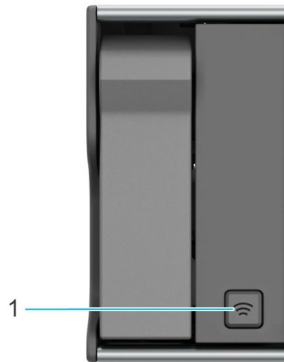

Figure 13. Left Control Panel (LCP) - Secondary panel - Quick Sync 2.0 (optional)

1. Quick Sync 2.0 button

Right Control Panel (RCP) - Primary view

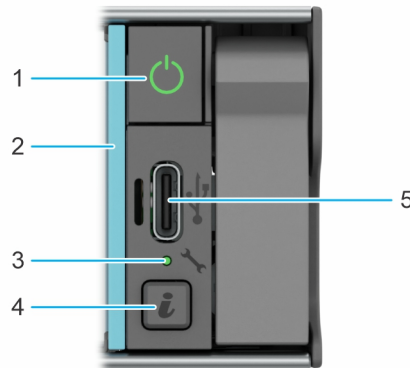

Figure 14. Right Control Panel (RCP) - Primary

Table 14. Right Control Panel (RCP) - Primary

Item	Indicator or button	Icon	Description
1	Power button		Indicates if the system is powered on or off. Press the power button to manually power on or off the system NOTE: Press the power button to gracefully shut down an ACPI-compliant operating system.
2	System health and System ID indicator	N/A	Indicates the status of the system.
3	iDRAC Direct LED indicator		The iDRAC Direct LED indicator lights up to indicate that the iDRAC Direct port is actively connected to a device.
4	System ID button		System ID allows user to physically locate the system..
5	Host/iDRAC Direct port (Type - C USB)		The iDRAC Direct port (Type - C USB) enables you to access the iDRAC direct Type - C USB features. For more information, see the iDRAC manuals . NOTE: You can configure iDRAC Direct by using a USB to Type - C USB cable, which you can connect to your laptop or tablet. Cable length should not exceed 3 feet (0.91 meters). Performance could be affected by cable quality.

Table 15. System health and system ID indicator codes

System health and system ID indicator code	Condition
Solid blue	Indicates that the system is powered on, is healthy, and system ID mode is not active. Press the system ID button to switch to system ID mode.
Blinking blue	Indicates that the system ID mode is active. Press the system ID button to switch to system health mode.
Blinking amber	Indicates that the system is experiencing a fault. Check the System Event Log for specific error messages. PowerEdge Manulas .

System configurations - rear view for PowerEdge R570 system

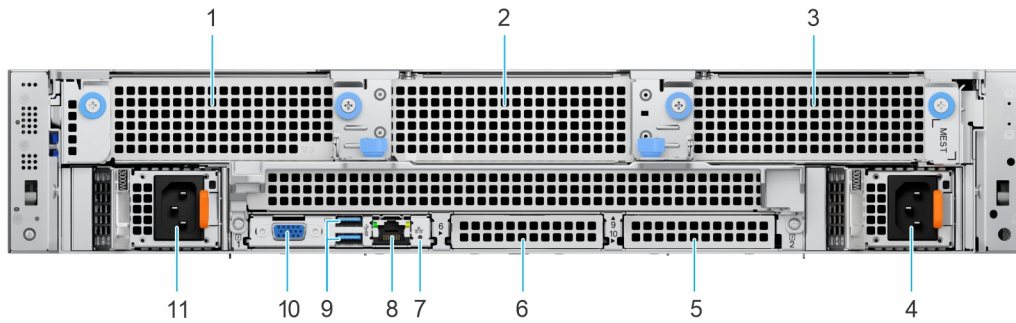







Figure 15. Rear view of the system with front I/O configuration

Table 16. Rear view of the system with front I/O configuration

Item	Ports, panels, or slots	Icon	Description
1	PCIe expansion card riser 1 blank	N/A	In front I/O configuration, the riser blank is installed in the expansion card riser bay.
2	PCIe expansion card riser 3 blank	N/A	
3	PCIe expansion card riser 5 blank	N/A	
4	Power supply unit (PSU2)		PSU2 is the secondary PSU of the system.
5	OCP NIC card filler bracket	N/A	In the front I/O configuration, an OCP filler bracket is installed in the OCP NIC card bay.
6	BOSS filler bracket	N/A	In the front I/O configuration, the BOSS file bracket is installed in BOSS-N1 DC-MHS bay.
7	iDRAC dedicated port		Enables you to remotely access iDRAC. When the front iDRAC port is connected to the network, the rear iDRAC port is automatically disabled.
8	USB 3.0 port		The USB port is 9-pin and 3.0-compliant. This port enables you to connect USB devices to the system.
9	VGA port		Enables you to connect a display device to the system.
10	Power supply unit (PSU1)		PSU1 is the primary PSU of the system.

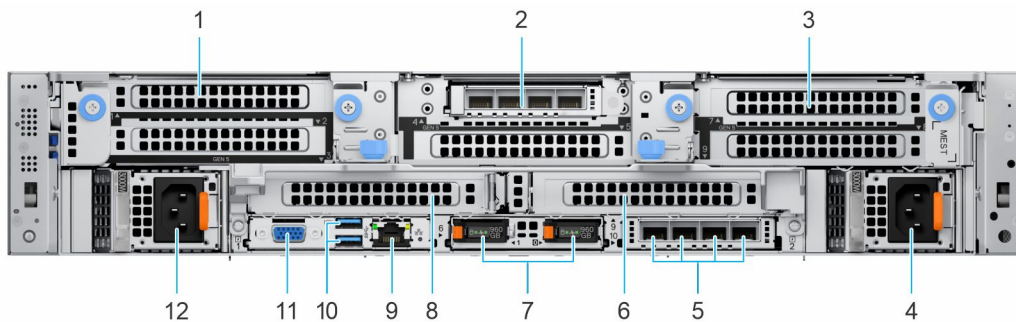







Figure 16. Rear View of the system with rear I/O configuration

Table 17. Rear view of the system with rear I/O configuration

items	Ports, panels, or slots	Icon	Description
1	PCIe expansion card riser 1	N/A	The expansion card riser enables you to connect PCI Express expansion cards.
2	PCIe expansion card riser 3	N/A	The expansion card riser enables you to connect PCI Express expansion cards.
3	PCIe expansion card riser 5	N/A	The expansion card riser enables you to connect PCI Express expansion cards.
4	Power supply unit (PSU2)		PSU2 is the secondary PSU of the system.
5	OCP NIC card	N/A	The OCP NIC card supports OCP 3.0. The NIC ports are integrated on the OCP card which is connected to the system board and also supports the iDRAC shared NIC feature.
6	PCIe expansion card riser 4	N/A	The expansion card riser enables you to connect PCI Express expansion cards.
7	BOSS-N1 DC-MHS module	N/A	BOSS module for internal system boot.
8	PCIe expansion card riser 2	N/A	The expansion card riser enables you to connect PCI Express expansion cards.
9	iDRAC dedicated port		Enables you to remotely access iDRAC. When the front iDRAC port is connected to the network, the rear iDRAC port is automatically disabled.
10	USB 3.0 port		The USB port is 9-pin and 3.0-compliant. This port enables you to connect USB devices to the system.
11	VGA port		Enables you to connect a display device to the system.
12	Power supply unit (PSU1)		PSU1 is the primary PSU of the system.

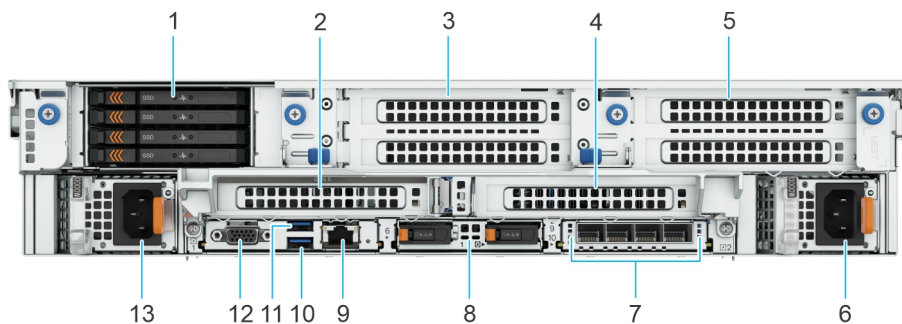







Figure 17. Rear view of the system with rear EDSFF E3.S NVMe drives

Table 18. Rear view of the system with rear EDSFF E3.S NVMe drives

items	Ports, panels, or slots	Icon	Description
1	EDSFF E3.S drives	N/A	Enables you to install drives that are supported on your system.
2	PCIe expansion card riser 2	N/A	The expansion card riser enables you to connect PCI Express expansion cards.
3	PCIe expansion card riser 3	N/A	The expansion card riser enables you to connect PCI Express expansion cards.
4	PCIe expansion card riser 4	N/A	The expansion card riser enables you to connect PCI Express expansion cards.
5	PCIe expansion card riser 5	N/A	The expansion card riser enables you to connect PCI Express expansion cards.
6	Power supply unit (PSU2)		PSU2 is the secondary PSU of the system.
7	OCP NIC card	N/A	The OCP NIC card supports OCP 3.0. The NIC ports are integrated on the OCP card which is connected to the system board and also supports the iDRAC shared NIC feature.
8	BOSS-N1 DC-MHS module	N/A	BOSS module for internal system boot.
9	iDRAC dedicated port		Enables you to remotely access iDRAC. When the front iDRAC port is connected to the network, the rear iDRAC port is automatically disabled.
10	USB 3.0 port		The USB port is 9-pin and 3.0-compliant. This port enables you to connect USB devices to the system.
11	USB 3.0 port		The USB port is 9-pin and 3.0-compliant. This port enables you to connect USB devices to the system.
12	VGA port		Enables you to connect a display device to the system.
13	Power supply unit (PSU1)		PSU1 is the primary PSU of the system.

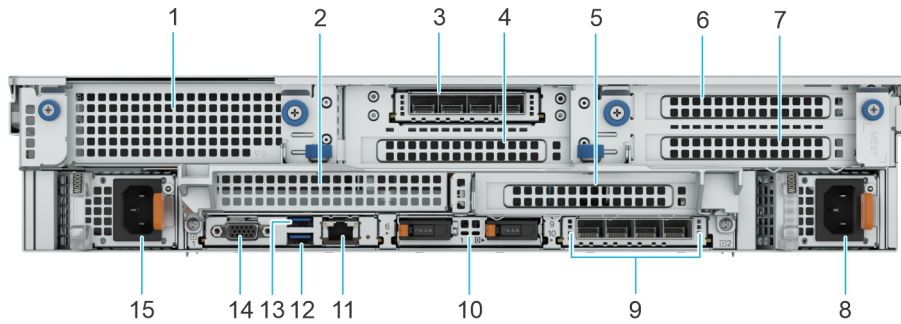



Figure 18. Rear view of the no backplane configuration system

Table 19. Rear view of the no backplane configuration system

items	Ports, panels, or slots	Icon	Description
1	PCIe expansion card riser 5 blank	N/A	Blank filler for the PCIe expansion riser slot.
2	PCIe expansion card riser 2 blank	N/A	Blank filler for the PCIe expansion riser slot.
3	PCIe expansion card riser OCP	N/A	PCIe expansion card riser OCP.
4	PCIe blank on expansion card riser	N/A	PCIe blank on expansion card riser
5	PCIe expansion card riser 4	N/A	The expansion card riser enables you to connect PCI Express expansion cards.
6	PCIe expansion card riser 5	N/A	The expansion card riser enables you to connect PCI Express expansion cards.
7	PCIe blank on expansion card riser	N/A	PCIe blank on expansion card riser
8	Power supply unit (PSU2)		PSU2 is the secondary PSU of the system.
9	OCP NIC card	N/A	The OCP NIC card supports OCP 3.0. The NIC ports are integrated on the OCP card which is connected to the system board and also supports the iDRAC shared NIC feature.
10	BOSS-N1 DC-MHS module	N/A	BOSS module for internal system boot.
11	iDRAC dedicated port		Enables you to remotely access iDRAC. When the front iDRAC port is connected to the network, the rear iDRAC port is automatically disabled.
12	USB 3.0 port		The USB port is 9-pin and 3.0-compliant. This port enables you to connect USB devices to the system.
13	USB 3.0 port		The USB port is 9-pin and 3.0-compliant. This port

Table 19. Rear view of the no backplane configuration system (continued)

items	Ports, panels, or slots	Icon	Description
			enables you to connect USB devices to the system.
14	VGA port		Enables you to connect a display device to the system.
15	Power supply unit (PSU1)		PSU1 is the primary PSU of the system.

System configurations - inside view for PowerEdge R570 system

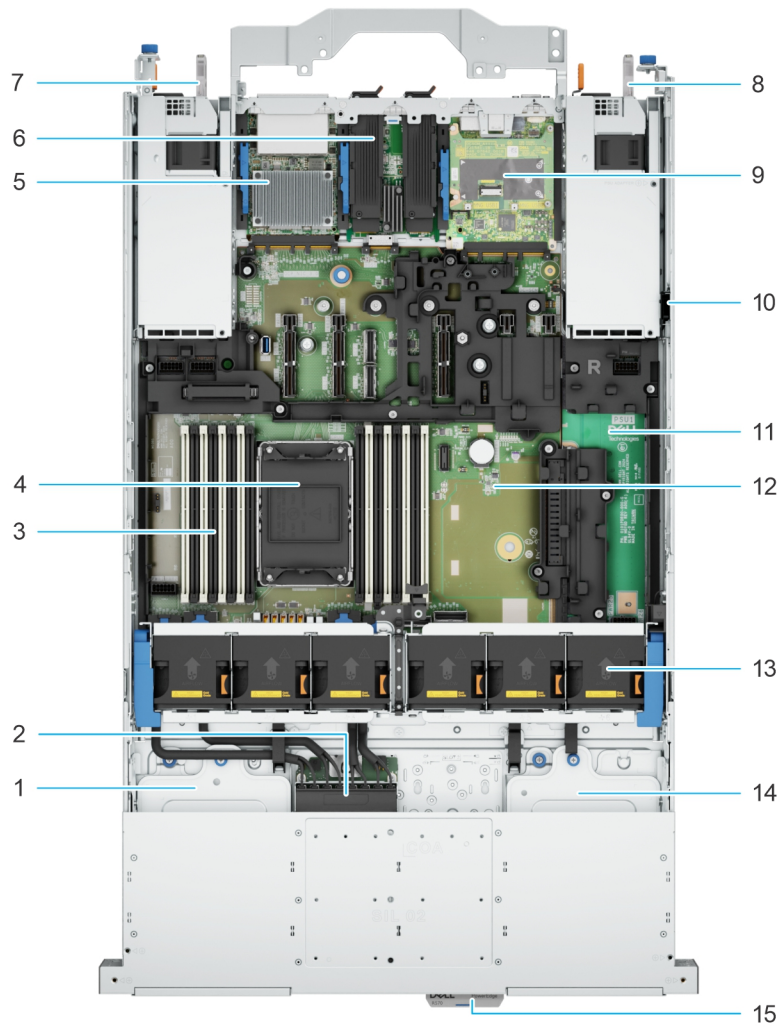

Figure 19. Inside the system

- | | |
|----------------------------------|---------------------------------|
| 1. Front OCP or Front BOSS-N1 | 2. Drive backplane |
| 3. DIMM slots | 4. Processor Heatsink Module |
| 5. OCP 3.0 NIC card | 6. BOSS-N1 DC-MHS module |
| 7. PSU 2 | 8. PSU 1 |
| 9. DC-SCM module | 10. Intrusion Switch |
| 11. Power interposer board (PIB) | 12. Host Processor Module (HPM) |
| 13. Cooling fans | 14. Front OCP |

15. Express Service Tag

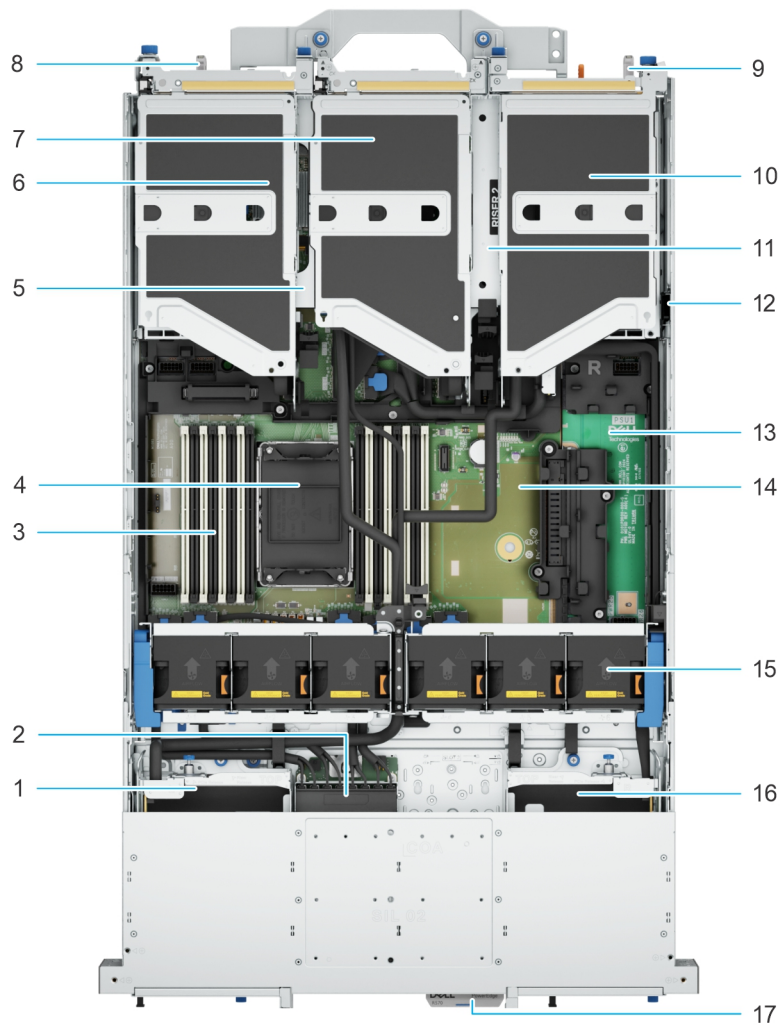

Figure 20. Inside the system with risers

- | | |
|----------------------------------|---------------------------------|
| 1. Front OCP or Front BOSS-N1 | 2. Drive backplane |
| 3. DIMM slots | 4. Processor Heatsink Module |
| 5. Riser 4 | 6. Riser 5 |
| 7. Riser 3 | 8. PSU 2 |
| 9. PSU 1 | 10. Riser 1 |
| 11. Riser 2 | 12. Intrusion Switch |
| 13. Power interposer board (PIB) | 14. Host Processor Module (HPM) |
| 15. Cooling fans | 16. Front OCP |
| 17. Express Service Tag | |

QR code for PowerEdge R570 system resources

Figure 21. QR code for PowerEdge R570



system

Chassis configurations

The PowerEdge™ R570 system supports:

Front Bay:

- Up to 12 x 3.5-inch SATA (HDD) RAID drives
- Up to 8 x 2.5-inch NVMe RAID drives
- Up to 8 x 2.5-inch NVMe drives
- Up to 8 x 2.5-inch SATA drives
- Up to 8 x 2.5-inch SATA/Universal drives
- Up to 16 x 2.5-inch SATA RAID drives
- Up to 24 x 2.5-inch SATA drives
- Up to 8 x EDSFF E3.S (hot-aisle) Gen5 NVMe drives
- Up to 8 x EDSFF E3.S (cold-aisle) Gen5 NVMe drives
- Up to 16 x EDSFF E3.S (cold-aisle) Gen5 NVMe drives
- Up to 16 x EDSFF E3.S (hot-aisle) Gen5 NVMe drives
- Up to 32 x EDSFF E3.S (hot-aisle) Gen5 NVMe drives

Rear Bay:

- Up to 4 x EDSFF E3.S Gen5 NVMe drives

i **NOTE:** For more information about how to hot swap NVMe PCIe SSD U.2 device, see the *Dell Express Flash NVMe PCIe SSD User's Guide* at **Browse all Products > Data Center Infrastructure > Storage Adapters & Controllers > Dell PowerEdge Express Flash NVMe PCIe SSD > Documentation > Manuals and Documents.**

Processor

Topics:

- [Processor features](#)

Processor features

The Intel® Xeon® 6 series processors meet diverse power, performance, and efficiency needs. Efficient-cores (E-cores) deliver high core density and exceptional performance per watt, while Performance-cores (P-cores) excel at the widest range of workloads with increased performance for AI and HPC. Intel® Xeon® 6 offers improved performance per watt, boosted performance per rack, upgraded memory speeds, enhanced I/O, expanded UPI speeds and added software extension security.

The following lists the features and functions of the Processors:

- Up to 144 cores and up to 330 W TDP for Intel® Xeon® 6 E-core processor
- Up to 86 cores and up to 350 W TDP for Intel® Xeon® 6 P-core processor
- Up to 8 channels DDR5 6400 MT/s (1DPC) and 5200 MT/s (2DPC)
- UPI 2.0 up to 24 GT/s
- Up to 88 PCIe 5.0 lanes
- R1S: Up to 136 PCIe 5.0 lanes
- PCIe bifurcation capability
- Intel® socket E2: LGA 4710-2

Supported processors

The following table shows the Intel® Xeon® 6 E-core processor SKUs that are supported on the R570.

Table 20. Intel® Xeon® 6 E-core processor supported in R570

Processor	Clock Speed (GHz)	Cache (M)	UPI (GT/s)	Cores	Threads	Turbo	Memory Speed (MT/s)	Memory Capacity	TDP
6780E	2.2	108	24	144	144	Turbo	6400	1 TB	330 W
6766E	1.9	108	24	144	144	Turbo	6400	1 TB	250 W
6756E	1.8	96	24	128	128	Turbo	6400	1 TB	225 W
6746E	2	96	24	112	112	Turbo	6400	1 TB	250 W
6740E	2.4	96	24	96	96	Turbo	6400	1 TB	250 W
6731E	2.2	96	24	96	96	Turbo	5600	1 TB	250 W
6710E	2.4	96	24	64	64	Turbo	5600	1 TB	205 W

Table 21. Intel® Xeon® 6 P-core processor supported in R570

Processor	Clock Speed (GHz)	Cache (M)	UPI (GT/s)	Cores	Threads	Turbo	Memory Speed (MT/s)	Memory Capacity	TDP
6787P	2	336	24	86	172	Turbo	6400	4 TB	350 W
6767P	2.4	336	24	64	128	Turbo	6400	4 TB	350 W
6747P	2.7	288	24	48	96	Turbo	6400	4 TB	330 W

Table 21. Intel® Xeon® 6 P-core processor supported in R570 (continued)

Processor	Clock Speed (GHz)	Cache (M)	UPI (GT/s)	Cores	Threads	Turbo	Memory Speed (MT/s)	Memory Capacity	TDP
6737P	2.9	144	24	32	64	Turbo	6400	4 TB	270 W
6730P	2.5	288	24	32	64	Turbo	6400	4 TB	250 W
6527P	3.0	144	24	24	48	Turbo	6400	4 TB	255 W
6724P	3.6	72	24	16	32	Turbo	6400	4 TB	210 W
6517P	3.2	72	24	16	32	Turbo	6400	4 TB	190 W
6505P	2.2	48	24	12	24	Turbo	6400	4 TB	150 W
6507P	3.5	48	24	8	16	Turbo	6400	4 TB	150 W
6781P#	2.0	336	N/A	80	160	Turbo	6400	2 TB	350 W
6761P#	2.5	336	N/A	64	128	Turbo	6400	2 TB	350 W
6741P#	2.5	288	N/A	48	96	Turbo	6400	2 TB	300 W
6731P#	2.5	144	N/A	32	64	Turbo	6400	2 TB	245 W
6521P#	2.6	144	N/A	24	48	Turbo	6400	2 TB	225 W
6511P#	2.3	72	N/A	16	32	Turbo	6400	2 TB	150 W

 **NOTE:** # indicates R1S CPU.

Memory subsystem

Topics:

- Supported memory
- System memory guidelines

Supported memory

Table 22. Memory technology comparison



Feature	PowerEdge R570 (DDR5)
DIMM type	RDIMM
Transfer speed	6400 MT/s(1DPC) and 5200 MT/s(2DPC)  NOTE: Maximum DIMM transfer speed support dependent on CPU SKU and DIMM population
Voltage	1.1 V

Table 23. Supported DIMMs

Rated DIMM Speed (MT/s)	DIMM Type	DIMM Capacity (GB)	Ranks per DIMM	Data Width	DIMM Volts (V)
6400	RDIMM	16	1	x8	1.1
6400	RDIMM	32	2	x8	1.1
6400	RDIMM	64	2	x4	1.1
6400	RDIMM	96	2	x4	1.1
6400	RDIMM	128	2	x4	1.1
6400	RDIMM	256	8	x4	1.1

 **NOTE:** The processor may reduce the performance of the rated DIMM speed.

System memory guidelines

The PowerEdge R570 system supports DDR5 registered DIMMs (RDIMMs). System memory holds the instructions that are started by the processor.

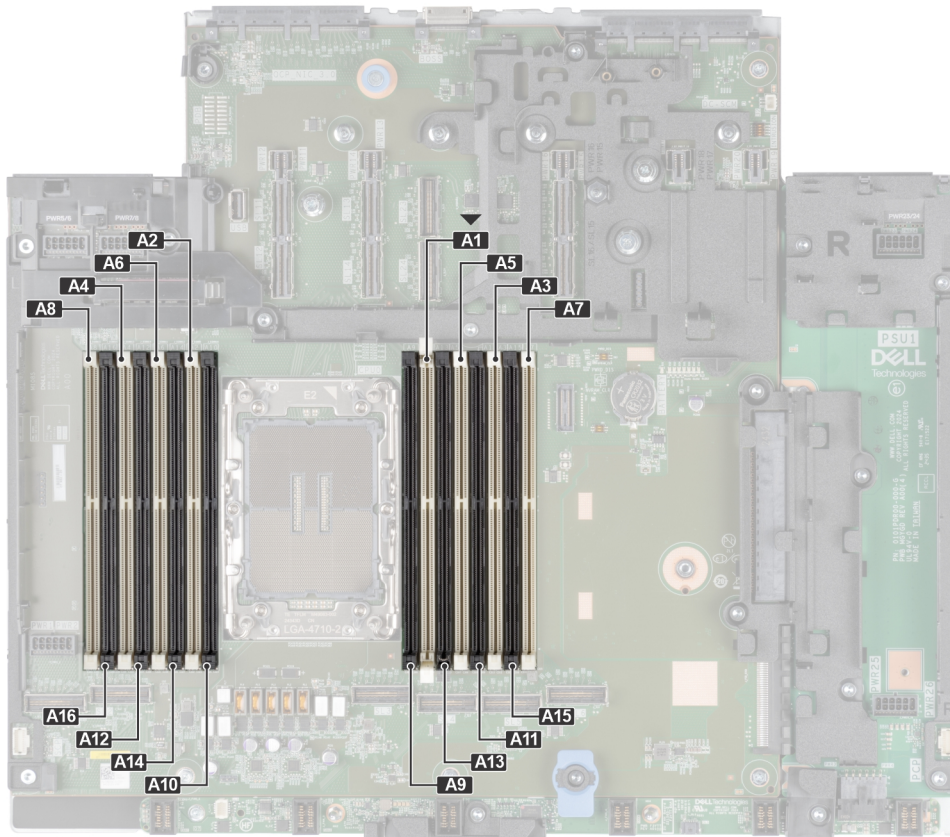

Figure 22. Memory channels

Memory channels are organized as follows:

Table 24. Memory channels

Processor	Channel A	Channel B	Channel C	Channel D	Channel E	Channel F	Channel G	Channel H
Processor 1	Slots A1 and A9	Slots A5 and A13	Slots A3 and A11	Slots A7 and A15	Slots A2 and A10	Slots A6 and A14	Slots A4 and A12	Slots A8 and A16

Table 25. Supported memory matrix

DIMM type	Rank	Capacity	DIMM rated voltage and speed	Operating Speed			
				Intel® Xeon® 6 E- core processor		Intel® Xeon® 6 P- core processor	
				1 DIMM per channel (DPC)	2 DIMM per channel (DPC)	1 DIMM per channel (DPC)	2 DIMM per channel (DPC)
RDIMM	1R	16 GB	DDR5 (1.1 V), 6400 MT/s	N/A	N/A	Up to 6400 MT/s	N/A
	2 R	32 GB	DDR5 (1.1 V), 6400 MT/s	Up to 6400 MT/s	N/A	Up to 6400 MT/s	Up to 5200 MT/s
		64 GB	DDR5 (1.1 V), 6400 MT/s	Up to 6400 MT/s	Up to 5200 MT/s	Up to 6400 MT/s	Up to 5200 MT/s
		96 GB	DDR5 (1.1 V), 6400 MT/s	N/A	N/A	Up to 6400 MT/s	Up to 5200 MT/s

Table 25. Supported memory matrix (continued)

DIMM type	Rank	Capacity	DIMM rated voltage and speed	Operating Speed			
				Intel® Xeon® 6 E- core processor		Intel® Xeon® 6 P- core processor	
				1 DIMM per channel (DPC)	2 DIMM per channel (DPC)	1 DIMM per channel (DPC)	2 DIMM per channel (DPC)
		128 GB	DDR5 (1.1 V), 6400 MT/s	N/A	N/A	Up to 6400 MT/s	Up to 5200 MT/s
	8 R	256 GB	DDR5 (1.1 V), 6400 MT/s	N/A	N/A	N/A	Up to 5200 MT/s

NOTE: The processor may reduce the performance of the rated DIMM speed.

NOTE: Maximum DIMM transfer speed support dependent on CPU SKU and DIMM population.

Table 26. Memory population guide for Intel® Xeon® 6 E- core

DIMM Capacity	1 DIMM	4 DIMMS	8 DIMMS (1DPC)	12 DIMMS	16 DIMMS (2DPC)
32 GB RDIMM	Yes	N/A	Yes	N/A	N/A
64 GB RDIMM	N/A	N/A	Yes	N/A	Yes

Table 27. Memory population guide for Intel® Xeon® 6 P- core

DIMM Capacity	1 DIMM	4 DIMMS	8 DIMMS (1DPC)	12 DIMMS	16 DIMMS (2DPC)
16 GB RDIMM	Yes	Yes	Yes	N/A	N/A
32 GB RDIMM	Yes	Yes	Yes	Yes	Yes
64 GB RDIMM	N/A	Yes	Yes	N/A	Yes
96 GB RDIMM	N/A	N/A	Yes	N/A	Yes
128 GB RDIMM	N/A	N/A	Yes	N/A	Yes
256 GB RDIMM	N/A	N/A	N/A	N/A	Yes

Table 28. Memory Capacity Requirement For Supported GPU Cards

Recommended System Memory Range (1.5x - 2x GPU Memory)					
GPU Name	GPU Memory	x1 GPU	x2 GPUs	x3 GPUs	x4 GPUs
L4	24 GB	36 - 48 GB	72 - 96 GB	108 - 144 GB	144 - 192 GB
L40S	48 GB	72 - 96 GB	144 - 192 GB	216 - 288 GB	N/A
H100NVL	94 GB	141 - 188 GB	282 - 376 GB	423 - 564 GB	N/A

NOTE: Follow the memory population guide to populate the system memory appropriately with the right capacity.

NOTE: Memory mirroring and Fault Resilient Mode(FRM) are supported in 8 or 16 DIMMs per CPU configuration.

NOTE: One DIMM per CPU configuration has limited features.

Storage

Topics:

- [Storage controllers](#)
- [Supported Drives](#)
- [Internal storage configuration](#)
- [External Storage](#)

Storage controllers

Dell RAID controller options offer performance improvements, including the fPERC solution. fPERC provides a base RAID HW controller without consuming a PCIe slot by using a small form factor and high-density connector to the base planar.

17G PERC Controller offerings are a heavy leverage of the 16G PERC family. The Value and Value Performance levels carry over to 17G from 16G.

i **NOTE:** PowerEdge does not support Tri-Mode, the mixing of SAS, SATA, and NVMe behind the same controller.

i **NOTE:** For more information about the features of the Dell PowerEdge RAID controllers (PERC), Software RAID controllers, or BOSS card, and on deploying the cards, see the storage controller documentation at [Storage Controller Manuals](#).

Server storage controllers User Guide

- [Server-Storage Controllers User's Guides](#), click [here](#)

Supported Drives

The table that is shown below lists the internal drives that are supported in R570.

Table 29. Supported drives

Form Factor	Type	Speed	Rotational Speed	Capacities
2.5 inches	SATA	6 Gbps	SSD	480 GB, 960 GB, 1.92 TB, 3.84 TB
2.5 inches	DC NVMe	Gen4	SSD	800 GB, 960 GB, 1.6 TB, 1.92 TB, 3.2 TB, 3.84 TB, 7.68 TB
2.5 inches	Ent NVMe	Gen4	SSD	1.6TB, 1.92 TB, 3.2 TB, 3.84 TB, 7.68 TB, 15.36 TB, 61.44 TB
3.5 inch	SATA	6 Gbps	7.2 K	2 TB, 4 TB, 8 TB, 12 TB, 16 TB, 20 TB, 24 TB, 32 TB
3.5 inch	SATA	12 Gbps	7.2 K	4 TB, 8 TB, 12 TB, 16 TB, 20 TB, 24 TB, 32 TB
M.2	NVMe	Gen4	N/A	480 GB, 960 GB
EDSFF E3.S	DC NVMe	Gen5	SSD	1.6 TB, 1.92 TB, 3.2 TB, 3.84TB
EDSFF E3.S	Ent NVMe	Gen5	SSD	3.2 TB, 3.84 TB, 6.4 TB, 7.68 TB, 15.36 TB, 30.72 TB, 61.44 TB

i **NOTE:** Planned Offerings are subject to change and may not be released as originally designed.

Hard Disk Drives (HDDs)

HDD Facts

HDD (Hard Disk Drive) is a storage media that are characterized by a set of spinning platters with arms to move recording heads over the surfaces to the right locations for reading and writing designated data.



Figure 23. Hard Disk Drive

The heads read or write the data and transfer it through the interface to the server. That interface for Dell standard enterprise HDDs can be either Serial Attached SCSI (SAS) or Serial ATA (SATA) and affects the speed at which data is transferred. Typically, SATA is 6 gigabits/sec. Where SAS is 12 gigabits/sec so throughput for SAS can be twice that of SATA. Additionally, due to better signal to noise ratios, SAS can have longer cable lengths, allowing it to connect to external data storage. SAS is also considered a more robust protocol.

Enterprise HDDs are typically used with multiple-user servers running enterprise software. Examples are transaction processing databases, internet infrastructure (email, webserver, e-commerce), scientific computing software, and nearline storage management software. Enterprise drives commonly operate continuously ("24/7") in demanding environments while delivering the highest possible performance without sacrificing reliability.

The fastest enterprise HDDs spin at 10,000 RPM and 15,000 RPM, and can achieve sequential media transfer speeds above 290 MB/s. Drives running at 10,000 or 15,000 RPM use smaller platters to mitigate increased power requirements and therefore generally have lower capacity than the highest capacity 7,200 RPM drives. 10 K and 15 K drives are labeled Mission Critical or Performance Optimized, while 7.2 K are called Business Critical or Capacity Optimized. Since 7.2 K drives spin slower, they can have larger platters and space for more platters in an HDD case. That allows for higher capacity drives – 16 TB, 18 TB and so on.

Random read/write task speeds are usually measured in IOPs (Input/Output operations per second) and for 15 K drives can be up to 290. That may sound like a lot but is dwarfed by IOPS (in the hundreds of thousands) available on SSDs. Below is a link to a chart showing HDD performance characteristics:

[HDD_Characteristic_and_Metrics](#)

Depending on the workload type, storage device capabilities are prioritized differently. Below is discussed several capabilities and the media that you would select for each.

- Better performance measured in IOPS: Storage performance for random workloads is measured in IOPS. When ordered in terms of general IOPS performance, choose 15 K, and then 10 K, then 7.2 K and within those SAS HDDs, NL-SAS HDDs, and SATA HDDs.
- Better performance is measured in throughput, or gigabytes per second (GB/s): Unless dealing with heavy sequential workloads that would benefit from flash technology, HDDs are a good choice for most sequential workloads, such as media viewing or database logging. NAND caching can further boost the performance of HDD storage as necessary.
- Lower latency: For workloads sensitive to latency, internal storage on the server itself typically has less latency than storage on external arrays where longer fetch times over the network can greatly add to existing storage latency. It is important to note that SSDs present much lower latency than mechanical HDDs.

- Greater capacity: For capacity-driven workloads, such as email archives, disk-based backup, and object storage applications, high IOPS or throughput performance may be less of a priority as compared to capacity. In this case, choose cost-efficient HDDs, which can offer the greatest capacity at the lowest cost.

While HDDs generally provide lower performance and higher latency than SSDs, they are still an excellent option when used as part of a complete storage strategy that balances cost per GB, capacity, application needs, and performance.

HDD feature matrix

Table 30. HDD feature matrix

Type	Interface	Form Factor	RPM	Security	Capacity	Description
HDD	12Gbps SAS	2.5	10K	ISE	2.4TB	Agnostic 10K SAS 2.4TB
HDD	12Gbps SAS	2.5	10K	FIPS	2.4TB	Agnostic 10K SAS FIPS 2.4TB
HDD	12Gbps SAS	2.5	10K	ISE	1.2TB	Agnostic 10K SAS 1.2TB
HDD	12Gbps SAS	2.5	10K	ISE	600GB	Agnostic 10K SAS 600GB
HDD	6Gbps SATA	3.5	7.2K	ISE	24TB	Agnostic 7.2K SATA 24TB
HDD	6Gbps SATA	3.5	7.2K	ISE	20TB	Agnostic 7.2K SATA 20TB
HDD	6Gbps SATA	3.5	7.2K	ISE	16TB	Agnostic 7.2K SATA 16TB
HDD	12Gbps SAS	3.5	7.2K	FIPS	16TB	Agnostic 7.2K SAS FIPS 16TB
HDD	6Gbps SATA	3.5	7.2K	ISE	12TB	Agnostic 7.2K SATA 12TB
HDD	6Gbps SATA	3.5	7.2K	ISE	8TB	Agnostic 7.2K SATA 8TB
HDD	12Gbps SAS	3.5	7.2K	FIPS	8TB	Agnostic 7.2K SAS FIPS 8TB
HDD	6Gbps SATA	3.5	7.2K	ISE	4TB	Agnostic 7.2K SATA 4TB
HDD	6Gbps SATA	3.5	7.2K	ISE	2TB	Agnostic 7.2K SATA 2TB
HDD	12Gbps SAS	3.5	7.2K	ISE	24TB	Agnostic 7.2K SAS 24TB
HDD	12Gbps SAS	3.5	7.2K	ISE	20TB	Agnostic 7.2K SAS 20TB
HDD	12Gbps SAS	3.5	7.2K	ISE	16TB	Agnostic 7.2K SAS 16TB
HDD	12Gbps SAS	3.5	7.2K	ISE	12TB	Agnostic 7.2K SAS 12TB
HDD	12Gbps SAS	3.5	7.2K	ISE	8TB	Agnostic 7.2K SAS 8TB
HDD	12Gbps SAS	3.5	7.2K	ISE	4TB	Agnostic 7.2K SAS 4TB

 **NOTE:** Planned Offerings are subject to change and may not be released as originally designed.

This document is updated as changes happen, so be sure to bookmark it rather than downloading an offline copy to stay with the latest information or see the [Drive and Platform Matrix](#).

Internal storage configuration

R570 available internal storage configurations:

- 12 x 3.5-inch SAS (HDD) RAID + 4 x EDSFF E3.S Gen5 NVMe drives
- 8 x 2.5-inch NVMe (SSD) RAID drives
- 8 x 2.5-inch NVMe (SSD) drives
- 8 x 2.5-inch SAS/SATA (HDD/SSD) drives
- 16 x 2.5-inch SAS/SATA (HDD/SSD) RAID drives
- 8 x EDSFF E3.S (cold-aisle) Gen5 NVMe drives

External Storage

The R570 supports the external storage device types that are listed in the table below.

Table 31. Support external storage devices

Device Type	Description
External Tape	Supports connection to external USB tape products
NAS/IDM appliance software	Supports NAS software stack
JBOD	Supports connection to 12 Gb MD-series JBODs

Networking

Topics:

- [Overview](#)
- [OCP 3.0 Support](#)

Overview

PowerEdge offers a wide variety of options to get information moving to and from our servers. Industry best technologies are chosen and these adapters are rigorously validated for worry-free, fully supported use in Dell servers.

OCP 3.0 Support

Supported OCP cards

Table 32. Supported OCP cards

Form factor	Port type	Port speed	Port count
OCP 3.0	QSFP56	100 GbE	2
	QSFP56	100 GbE	2
	SFP28	25 GbE	4
	SFP28	25 GbE	2
	QSFP56	100 GbE	2
	BT	1 GbE	4
	BT	10 GbE	4
	BT	10 GbE	2
	SFP28	25 GbE	4
	SFP28	25 GbE	4
	QSFP56	100 GbE	2
	BT	10 GbE	2
	BT	10 GbE	2
	SFP28	25 GbE	2
	BT	1 GbE	2

OCP NIC 3.0 vs 2.0

Table 33. OCP 3.0 and 2.0 NIC comparison

Form Factor	OCP 2.0 (LOM Mezz)	OCP 3.0	Notes
PCIe Gen	Gen3	Gen5	Supported OCP3 is SFF (small form factor).
Max PCIe Lanes	Up to x16	Up to x16	See server slot priority matrix.
Shared LOM	Yes	Yes	Only OCP on slot 10 (rear IO) can support iDRAC port redirect as shared NIC.
Aux Power	Yes	Yes	Used for Shared LOM

OCP form factors

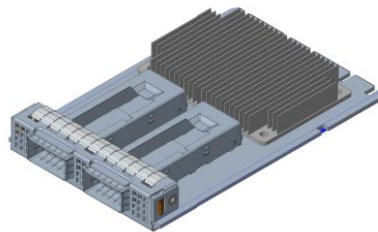

Figure 24. OCP 3.0 Small Card Form Factor (LS)

For the process of installing the OCP card, see the installation and service manual for R570 at the dell support site.

PCIe subsystem

Topics:

- PCIe risers

PCIe risers

Shown below are the riser offerings for the platform.

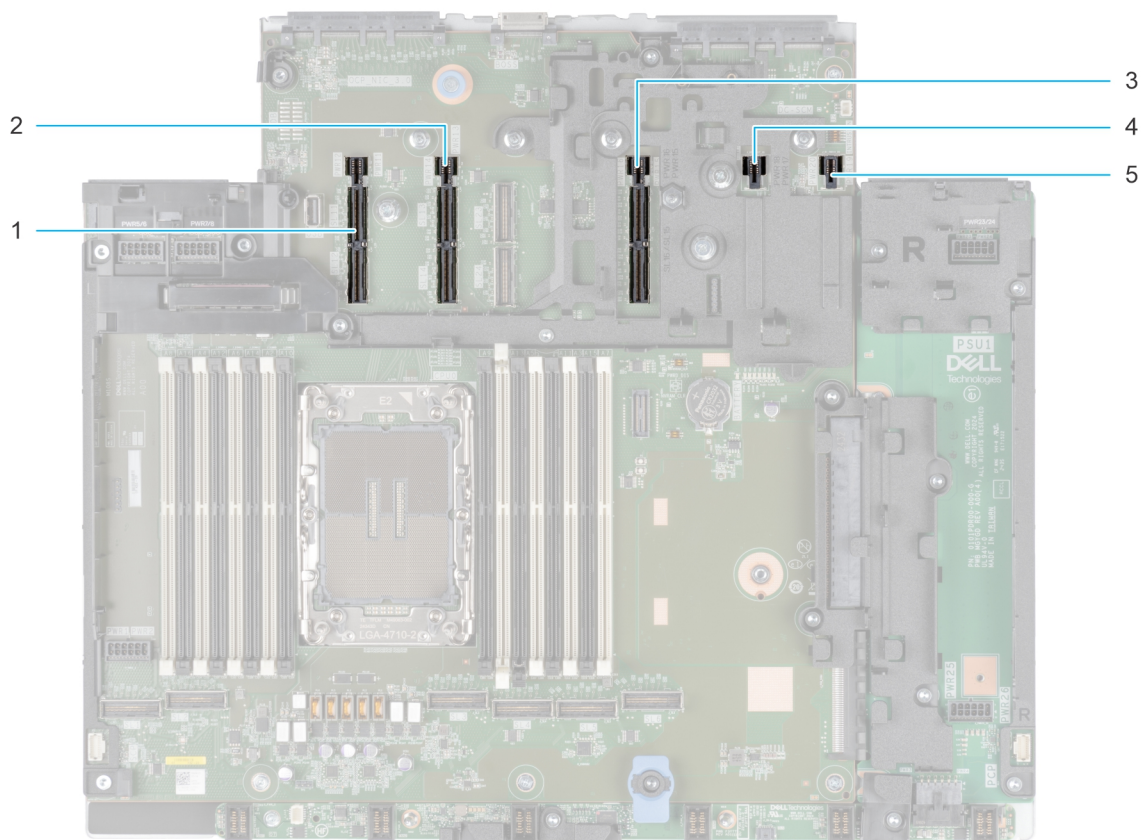

Figure 25. Riser connector location on HPM board

1. Riser 5
2. Riser 4
3. Riser 3
4. Riser power connector
5. Riser power connector

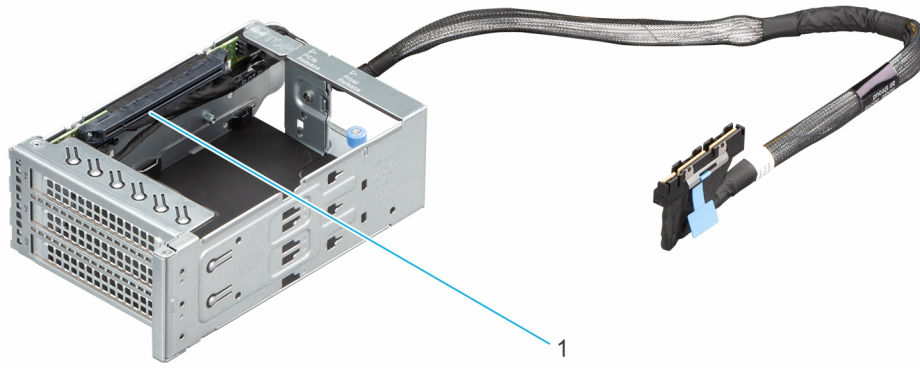

Figure 26. Riser RF1

1. Slot 31

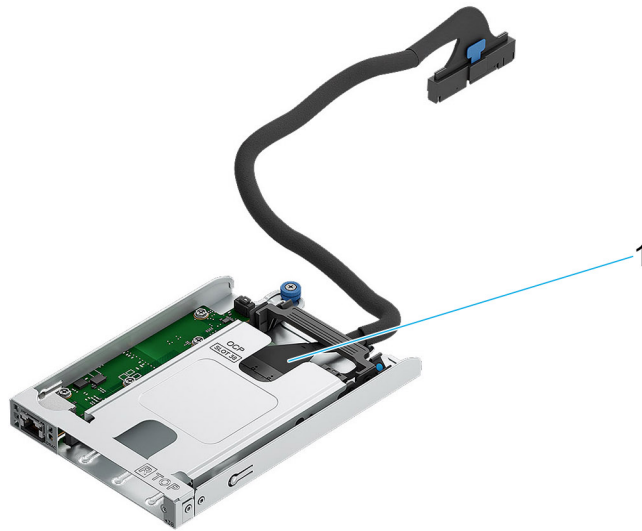

Figure 27. Riser RF2

1. Slot 34

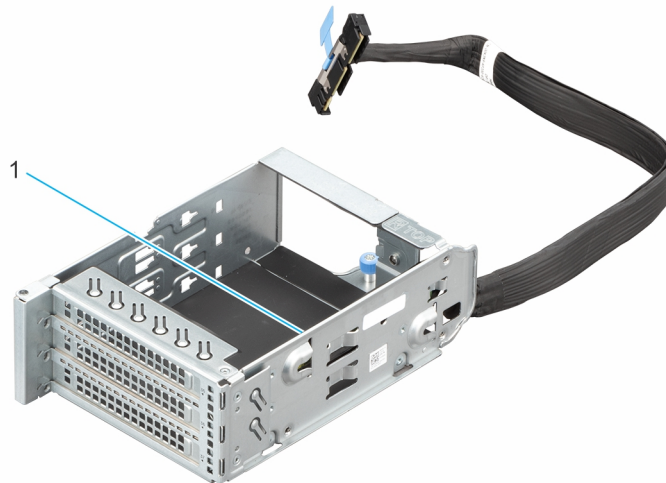

Figure 28. Riser RF3

1. Slot 36

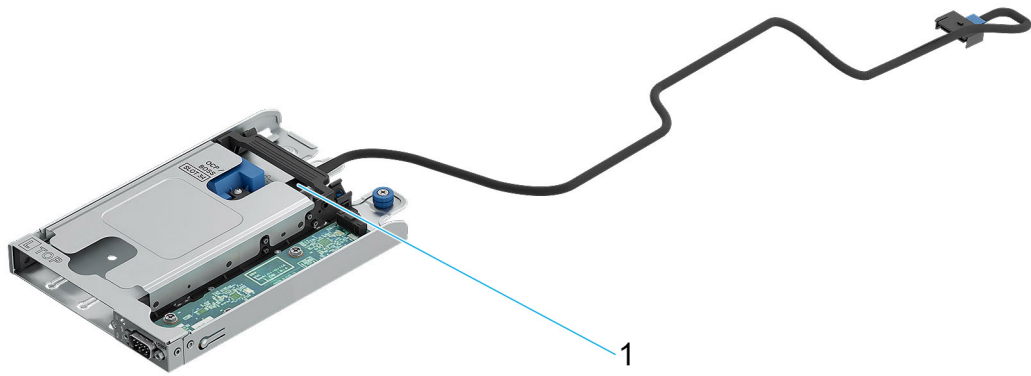

Figure 29. Riser RF4

- 1. Slot 38

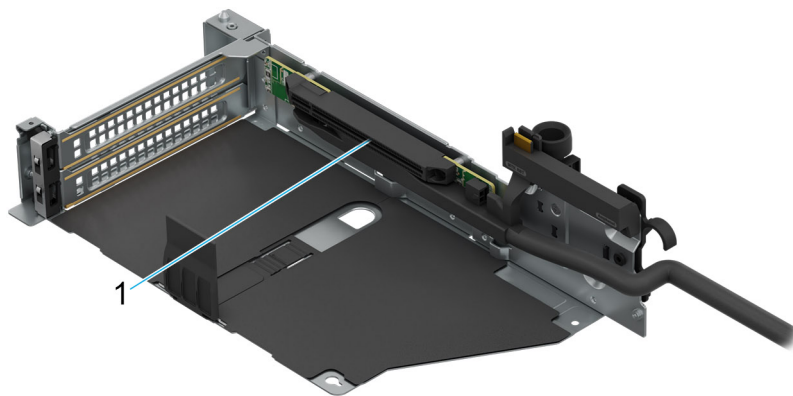

Figure 30. Riser R1

- 1. Slot 2

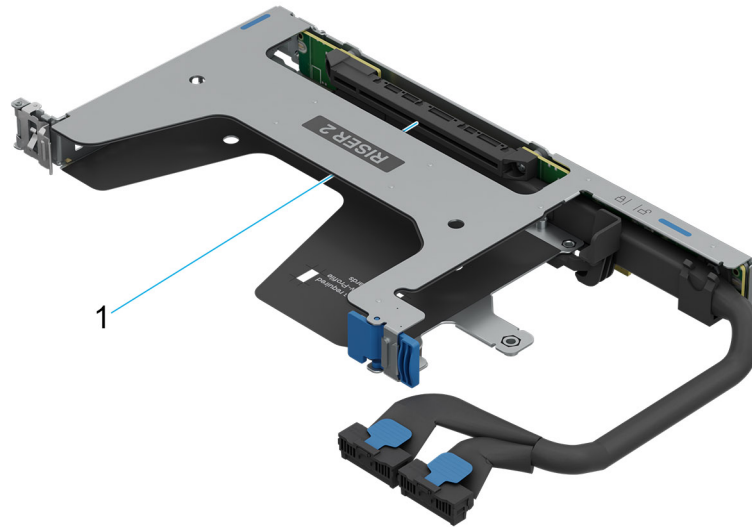

Figure 31. Riser R2

- 1. Slot 3

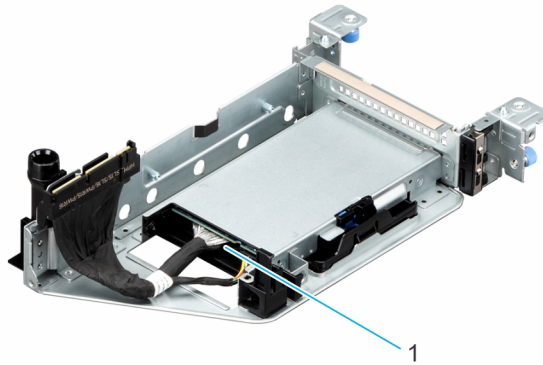

Figure 32. Riser R3

- 1. Slot 4

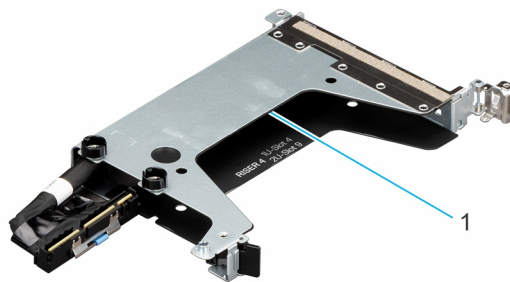

Figure 33. Riser R4

- 1. Slot 9

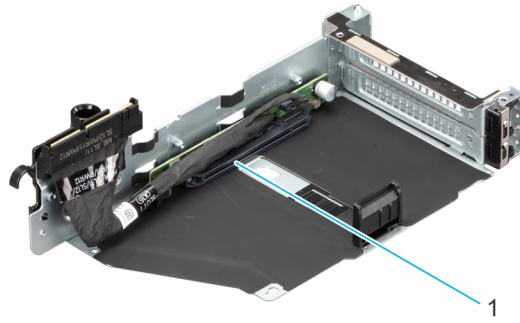

Figure 34. Riser R5

1. Slot 7

Table 34. PCIe Riser Configurations

Config No.	Riser configuration	No. of Processors	PERC type supported	Rear storage possible
RC 0	NO RSR	1	Front PERC	No
RC 1	R1x+R2t+R3e+R4b+R5b	1	Front PERC	No
RC 2	RF2a+RF4b	1	N/A	No
RC 3	RF1a+RF3c	1	N/A	No
RC 4	RF1a+RF2a+RF3d+RF4a	1	N/A	No
RC 5	R3f+R4b+R5b	1	Front PERC	No
RC 6	R1x+R3b+R4b+R5b	1	N/A	No
RC 7	R3f+R4b+R5b	1	PERC Adapter	Yes
RC 8	RF1a+RF4c+R1x+R3b+R5b	1	N/A	No
RC 9	R4b+R5b	1	Front PERC	No
RC 10	R2t+R3e+R4b+R5b	1	PERC Adapter	No
RC 11	R3e+R4b+R5b	1	N/A	No

i NOTE: Riser Support Guidelines

- Intel Xeon 6 processor P-core R1S processors provide a higher number of PCIe lanes compared to standard Intel® Xeon 6 processor P-core processors.
- On the PowerEdge R570 platform:
 - Risers RC1, RC4, RC6, RC8, RC10, and RC11 support only R1S processors.
 - Risers RC2 and RC9 support both R1S and standard single-processor configurations, depending on the storage configuration requirements.
- Riser compatibility is subject to platform-specific design and lane allocation constraints.
- Select compatible storage configurations to ensure system integrity and optimal performance.

Power, thermal, and acoustics

PowerEdge servers have an extensive collection of sensors that automatically track thermal activity, which helps to regulate temperature by reducing server noise and power consumption. The table below lists the tools and technologies Dell offers to lower power consumption and increase energy efficiency.

Topics:

- [Power](#)
- [Thermal](#)
- [Acoustics](#)

Power

Table 35. Power tools and technologies

Feature	Description
Power Supply Units(PSU) portfolio	Dell's PSU portfolio includes intelligent features such as dynamically optimizing efficiency while maintaining availability and redundancy. Find additional information in the Power supply units section.
Tools for right sizing	Enterprise Infrastructure Planning Tool (EIPT) is a tool that can help you determine the most efficient configuration possible. With Dell's EIPT, you can calculate the power consumption of your hardware, power infrastructure, and storage at a given workload. Learn more at Dell EIPT .
Industry Compliance	Dell's servers are compliant with all relevant industry certifications and guide lines, including 80 PLUS, Climate Savers and ENERGY STAR.
Power monitoring accuracy	PSU power monitoring improvements include: <ul style="list-style-type: none"> • Dell's power monitoring accuracy is currently 1%, whereas the industry standard is 5% • More accurate reporting of power
Rack infrastructure	Dell offers some of the industry's highest-efficiency power infrastructure solutions, including: <ul style="list-style-type: none"> • Power distribution units (PDUs) • Uninterruptible power supplies (UPSs) • Energy Smart containment rack enclosures • AC Blind Mate Find additional information at: Power and Cooling

Power Supply Units

Energy Smart power supplies have intelligent features, such as the ability to dynamically optimize efficiency while maintaining availability and redundancy. Also featured are enhanced power-consumption reduction technologies, such as high-efficiency power conversion and advanced thermal-management techniques, and embedded power-management features, including high-accuracy power monitoring. The table below shows the power supply unit options that are available for the R570.

Table 36. PSU specifications

PSU	Classes	Heat dissipation (maximum) (BTU/hr)	Frequency (Hz)	AC Voltage			DC Voltage			Current (A)
				200—240 V	100—120 V	277 V	240 V	-(48—60) V	336 V	
800 W mixed mode	Platinum	3000	50/60	800 W	800 W	N/A	N/A	N/A	N/A	9.2—4.5 A
	Titanium	3000	50/60	800 W	800 W	N/A	N/A	N/A	N/A	9.2—4.5 A
	N/A	3000	N/A	N/A	N/A	N/A	800 W	N/A	N/A	3.7 A
1100 W	Titanium	4100	50/60	1100 W	1050 W	N/A	N/A	N/A	N/A	12—6.1 A
	Platinum	4100	50/60	1100 W	1050 W	N/A	N/A	N/A	N/A	12—6.1 A
	N/A	4100	N/A	N/A	N/A	N/A	1100 W	N/A	N/A	5.1 A
1400 W -48 VDC	Titanium	5310	N/A	N/A	N/A	N/A	N/A	1400 W	N/A	33 A
1500 W 227 VAC	Titanium	5625	50/60	N/A	N/A	N/A	1500 W	N/A	N/A	6.1 A
	N/A	5625	N/A	N/A	N/A	N/A	N/A	N/A	1500 W	4.91 A
1500 W mixed mode	Titanium	5625	50/60	1500 W	1050 W	N/A	N/A	N/A	N/A	12—8.2 A
	N/A	5625	N/A	N/A	N/A	N/A	1500 W	N/A	N/A	6.8 A
1800 W mixed mode	Titanium	6750	50/60	1800 W	1050 W	N/A	N/A	N/A	N/A	9.8—8.2 A
	N/A	6750	N/A	N/A	N/A	N/A	1800 W	N/A	N/A	8.2 A



Figure 35. PSU power cables

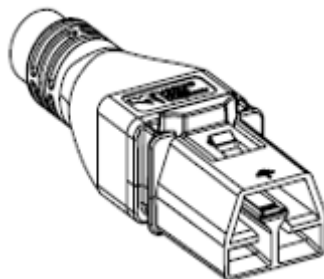

Figure 36. APP 2006G1 power cable



Figure 37. LOTES APOWA048 power cable

Table 37. PSU power cables

Form factor	Output	Power cable
Redundant 60 mm	800 W mixed mode	C13
	1100w mixed mode	C13
	1400w -48v DC	LOTES APOWA048
	1500 W mixed mode	C13
	1500w 277v	APP2006G1/2006G3
	1800 W mixed mode	C13

Thermal

PowerEdge servers have an extensive collection of sensors that automatically track thermal activity, which helps regulate temperature thereby reducing server noise and power consumption.

Thermal design

Thermal management of the platform helps deliver high performance with the right amount of cooling to components, while maintaining the lowest fan speeds possible. This is done across a wide range of ambient temperatures from 10°C to 35°C (50°F to 95°F) and to extended ambient temperature ranges.

1. Reliability	<ul style="list-style-type: none"> • Component hardware reliability remains the top thermal priority. • System thermal architectures and thermal control algorithms are designed to ensure there are no tradeoffs in system level hardware life.
2. Performance	<ul style="list-style-type: none"> • Performance and uptime are maximized through the development of cooling solutions that meet the needs of even the densest of hardware configurations.
3. Efficiency	<ul style="list-style-type: none"> • 17G servers are designed with an efficient thermal solution to minimize power and airflow consumption, and/or acoustics for acoustical deployments. • Dell's advanced thermal control algorithms enable minimization of system fan speeds while meeting the above Reliability and Performance tenets.
4. Forward Compatibility	<ul style="list-style-type: none"> • Forward compatibility means that thermal controls and thermal architecture solutions are robust to scale to new components that historically would have otherwise required firmware updates to ensure proper cooling. • The frequency of required firmware updates is thus reduced.

Figure 38. Thermal design characteristics

The thermal design of the PowerEdge R570 reflects the following:

- Optimized thermal design: The system layout is architected for optimum thermal design.
- System component placement and layout are designed to provide maximum airflow coverage to critical components with minimum expense of fan power.

- Comprehensive thermal management: The thermal control system regulates the fan speed based on several different responses from all system-component temperature sensors, and inventory for system configurations. Temperature monitoring includes components such as processors, DIMMs, chipset, the inlet air ambient, hard disk drives, and OCP.
- Open and closed loop thermal fan speed control: Open loop thermal control uses system configuration to determine fan speed based on inlet air ambient temperature. Closed loop thermal control method uses feedback temperatures to dynamically determine proper fan speeds.
- User-configurable settings: With the understanding and realization that every customer has unique set of circumstances or expectations from the system. For more information, see the Dell PowerEdge R570 Installation and Service Manual at [PowerEdge Manuals](#) and "Advanced Thermal Control: Optimizing across Environments and Power Goals" on Dell.com.
- Cooling redundancy: The R570 allows N+1 fan redundancy, allowing continuous operation with one fan failure in the system.
- Environmental Specifications: The optimized thermal management makes the R570 reliable under a wide range of operating environments.

Acoustics

Acoustical configurations of R570

Dell PowerEdge R570 is a rack server with acoustical output that spans from levels suitable for an office environment to those found in data centers.

R570 is designed for use in a data center, but, some users may prefer to use it in a quieter setting. Please note however in most cases, the idle air mover speed of the system cannot be lowered without changing the configuration of the system, and in some cases, even a configuration change may not reduce idle air mover speeds.

Table 38. Configurations tested for acoustical experience

Configurations	Low End Configuration with Quietest Acoustical Experience for Publication	GPU Configuration with Quietest Operating Acoustical Experience for Publication	Typical - 1 (2.5" Drives)*	Typical - 1 (Front I/O)	Typical - 1 (3.5" Drives)	Typical - 2 GPU Based
CPU TDP	150 W	150 W	270 W	270 W	270 W	300 W
CPU Quantity	1	1	1	1	1	1
RDIMM Memory	32G DDR5	32G DDR5	32G DDR5	32G DDR5	32G DDR5	32G DDR5
Memory Quantity	1	16	16	16	16	16
Backplane Type	2.5" x 8 BP	8 x E3.S (cold aisle)	2.5" x 24 BP	8 x E3.S (cold aisle)	12x 3.5" BP + 4 x E3.S Rear BP	8 x E3.S (cold aisle)
HDD Type	SATA SSD	E3.S	SATA SSD	E3.S	3.5 HDD, E3.S	E3.S
HDD Quantity	8	8	16	8	12+4	8
PSU Type	800 W	800 W	800 W	800 W	800 W	1500 W
PSU Quantity	2	2	2	2	2	2
OCP	2 x 10G x1	2 x 10G x1	2 x 100G x1	2 x 100G x2	2 x 100G x1	2 x 100G x1
PCI 1	N/A	N/A	N/A	N/A	N/A	N/A
PCI 2	N/A	N/A	N/A	N/A	N/A	H100
PCI 3	N/A	N/A	N/A	N/A	N/A	N/A
PCI 4	N/A	N/A	N/A	N/A	N/A	H100
PCI 5	N/A	N/A	N/A	N/A	N/A	N/A
PCI 6	N/A	N/A	N/A	N/A	N/A	N/A

Table 38. Configurations tested for acoustical experience (continued)

Configurations	Low End Configuration with Quietest Acoustical Experience for Publication	GPU Configuration with Quietest Operating Acoustical Experience for Publication	Typical - 1 (2.5" Drives)*	Typical - 1 (Front I/O)	Typical - 1 (3.5" Drives)	Typical - 2 GPU Based
PCI 7	N/A	N/A	N/A	N/A	Adapter H365	H100
PCI 31	N/A	L4	N/A	N/A	N/A	N/A
Front PERC	Front H365	N/A	Front H365	N/A	N/A	N/A

Table 39. Acoustical experience of R570 configurations

Configurations	Low End Configuration with Quietest Acoustical Experience for Publication	GPU Configuration with Quietest Operating Acoustical Experience for Publication	Typical - 1 (2.5" Drives)*	Typical - 1 (Front I/O)	Typical - 1 (3.5" Drives)	Typical - 2 GPU Based	
Acoustical Performance: Idle/ Operating @ 25 °C Ambient							
L _{wA,m} (B)	Idle ⁽⁴⁾	5.5	6.6	6.7	6.1	6.5	6.8
	Operating/ Customer Usage Operating ⁽⁵⁾ (6)	5.5	7.9	6.7	6.1	6.5	9.0
K _v (B)	Idle ⁽⁴⁾	0.4	0.4	0.4	0.4	0.4	0.4
	Operating/ Customer Usage Operating ⁽⁵⁾ (6)	0.4	0.4	0.4	0.4	0.4	0.4
L _{pA,m} (dB)	Idle ⁽⁴⁾	37	50	51	43	47	51
	Operating/ Customer Usage Operating ⁽⁵⁾ (6)	37	66	51	43	7	75
Prominent discrete tones ⁽³⁾	Prominence ratio < 15 dB					Prominence ratio < 19 dB	
Acoustical Performance: Idle @ 28 °C Ambient							
L _{wA,m} ⁽¹⁾ (B)	6.0	6.8	7.3	6.3	7.6	7.1	
K _v (B)	0.4	0.4	0.4	0.4	0.4	0.4	
L _{pA,m} ⁽²⁾ (dB)	43	53	58	46	60	54	
Acoustical Performance: Max. Loading @ 35 °C Ambient							
L _{wA,m} ⁽¹⁾ (B)	8.6	8.6	8.6	8.6	8.6	9.0	
K _v (B)	0.4	0.4	0.4	0.4	0.4	0.4	
L _{pA,m} ⁽²⁾ (dB)	69	69	69	69	70	75	

⁽¹⁾LwA, m: The declared mean A-weighted sound power level (LwA) is calculated per section 5.2 of ISO 9296 (2017) with data collected using the methods that are described in ISO 7779 (2010). Engineering data presented here may not be fully compliant with the ISO 7779 declaration requirement.

⁽²⁾LpA, m: The declared mean A-weighted emission sound pressure level is at the bystander position per section 5.3 of ISO 9296 (2017) and measured using methods that are described in ISO 7779 (2010). The system is placed on a standard table, 75 cm above a reflective floor. Data presented here may not be fully compliant with ISO 7779.

⁽³⁾Prominent tones: Criteria of D.6 and D.11 of ECMA-74 (17th ed., December 2019) are followed to determine if discrete tones are prominent and to report them, if so.

⁽⁴⁾Idle mode: The steady-state condition in which the server is energized but not operating any intended function.

⁽⁵⁾Operating mode: The maximum of the steady state acoustical output at 50% of CPU TDP or active HDDs per C.9.3.2 in ECMA-74 (17th ed., December 2019).

Rack, rails, and cable management

Topics:

- [Rails and cable management information](#)

Rails and cable management information

The rail offerings for the PowerEdge R570 consist of two general types: sliding and static. The cable management offerings consist of an optional cable management arm (CMA) and an optional strain relief bar (SRB).

See the *Enterprise Systems Rail Sizing and Rack Compatibility Matrix* available at [rail-rack matrix](#) for information regarding:

- Specific details about rail types.
- Rail adjustability ranges for various rack mounting flange types.
- Rail depth with and without cable management accessories.
- Rack types that are supported for various rack mounting flange types.

Key factors governing proper rail selection include the following:

- Spacing between the front and rear mounting flanges of the rack.
- Type and location of any equipment that is mounted in the back of the rack such as power distribution units (PDUs).
- Overall depth of the rack.

Sliding rails features summary

The sliding rails allow the system to be fully extended out of the rack for service. There are two types of sliding rails available, ReadyRails II sliding rails and Stab-in/Drop-in sliding rails. The sliding rails are available with or without the optional cable management arm (CMA) or strain relief bar (SRB).

B21 ReadyRails sliding rails for 4-post racks

- Supports drop-in installation of the chassis to the rails.
- Support for tool-less installation in 19" EIA-310-E compliant square or unthreaded round hole 4-post racks including all generations of the Dell racks.
- Support for tooled installation in 19" EIA-310-E compliant threaded hole 4-post racks.
- Support full extension of the system out of the rack to allow serviceability of key internal components.
- Support for optional strain relief bar (SRB).
- Support for an optional cable management arm (CMA).

NOTE: For situations where CMA support is not required, the outer CMA mounting brackets can be uninstalled from the sliding rails. This reduces the overall length of the rails and eliminates the potential interference with rear-mounted PDUs or the rear rack door.

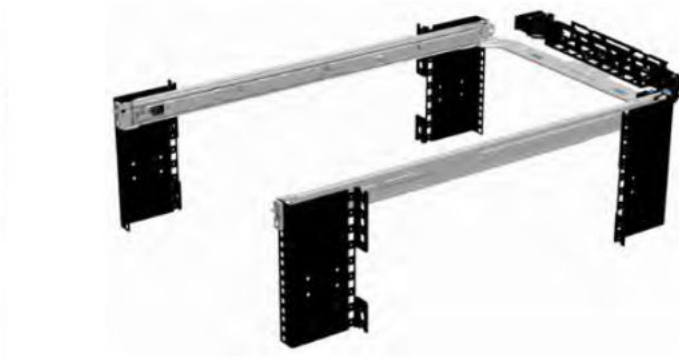

Figure 39. Sliding rails with optional CMA



Figure 40. Sliding rails with optional SRB

B22 Stab-in/Drop-in sliding rails for 4-post racks

- Supports drop-in or stab-in installation of the chassis to the rails.
- Support for tool-less installation in 19" EIA-310-E compliant square, unthreaded round hole racks including all generations of the Dell racks. Also, supports tool-less installation in threaded round hole 4-post racks.
- Support for tool-less installation in Dell Titan-S or Titan-D racks.
- Support full extension of the system out of the rack to allow serviceability of key internal components.
- Support for an optional cable management arm (CMA).
- Support for optional strain relief bar (SRB).

i NOTE: For situations where CMA support is not required, the outer CMA mounting brackets can be uninstalled from the sliding rails. This reduces the overall length of the rails and eliminates the potential interference with rear-mounted PDUs or the rear rack door.

B20 static rails summary

The static rails offer a greater adjustability range and a smaller overall mounting footprint than the sliding rails because of their reduced complexity and lack of need for CMA support. The static rails support a wider variety of racks than the sliding rails. However, they do not support serviceability in the rack and are thus not compatible with the CMA. The static rails are also not compatible with SRB.



Figure 41. Static rails

Static rails features summary

Static rails for 4-post and 2-post racks:

- Supports Stab-in installation of the chassis to the rails.
- Support tool-less installation in 19" EIA-310-E compliant square or unthreaded round hole 4-post racks including all generations of Dell racks.
- Support tooled installation in 19" EIA-310-E compliant threaded hole 4-post and 2-post racks.
- Support for tooled installation in Dell Titan-S or Titan-D rack.

i NOTE:

- Screws are not included with the static rail kit since racks are offered with various thread types. The screws are provided for mounting static rails in racks with threaded mounting flanges.
- Screw head diameter should be 10 mm or less.

2-Post racks installation

If installing to 2-Post (Telco) racks, the ReadyRails II static rails (B20) must be used. Sliding rails support mounting in 4-post racks only.



Figure 42. Static rails in 2-post center mount configuration

Installation in the Dell Titan-S or Titan-D racks

For tool-less installation in Titan or Titan-D racks, the Stab-in/Drop-in sliding rails (B22) must be used. This rail collapses down sufficiently to fit in the rack with mounting flanges that are spaced about 24 inches apart from front to back. The Stab-in/Drop-in sliding rail allows bezels of the servers and storage systems to be aligned when installed in these racks. For tooled installation, Stab-in Static rails (B20) must be used for bezel alignment with storage systems.

Rack Installation

Drop-in design means that the system is installed vertically into the rails by inserting the standoffs on the sides of the system into the J-slots in the inner rail members with the rails in the fully extended position. The recommended method of installation is to first insert the rear standoffs on the system into the rear J-slots on the rails to free up a hand and then rotate the system down into the remaining J-slots while using the free hand to hold the rail against the side of the system.

Stab-in design means that the inner (chassis) rail members must first be attached to the sides of the system and then inserted into the outer (cabinet) members installed in the rack.

Installing the system into the rack (option A: Drop-In)

1. Pull the inner rails out of the rack until they lock into place.

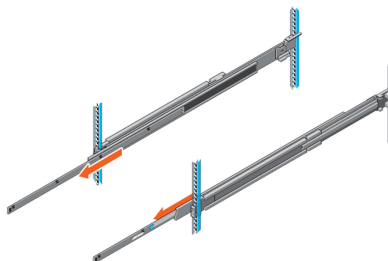

Figure 43. Pull out inner rail

2. Locate the rear rail standoff on each side of the system and lower them into the rear J-slots on the slide assemblies.
3. Rotate the system downward until all the rail standoffs are seated in the J-slots.

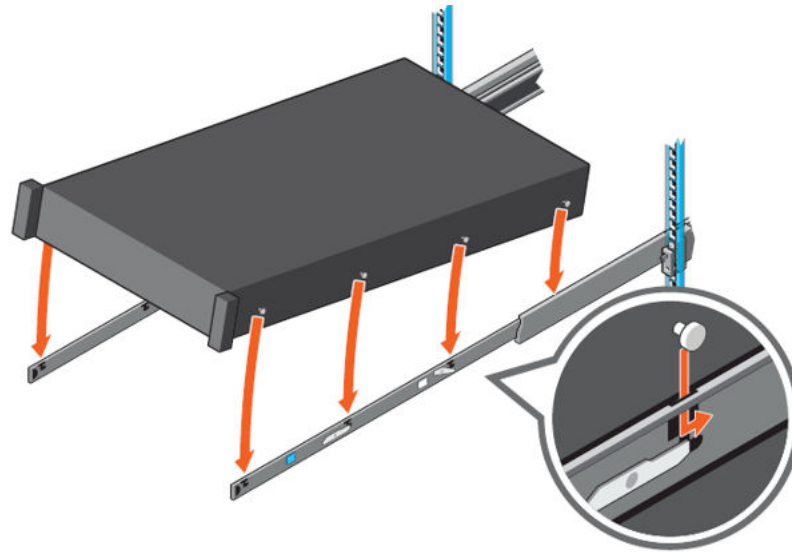

Figure 44. Rail standoffs seated in J-slots

4. Push the system inward until the lock levers click into place.
5. Pull the blue side release lock tabs forward or backward on both rails and slide the system into the rack until the system is in the rack.

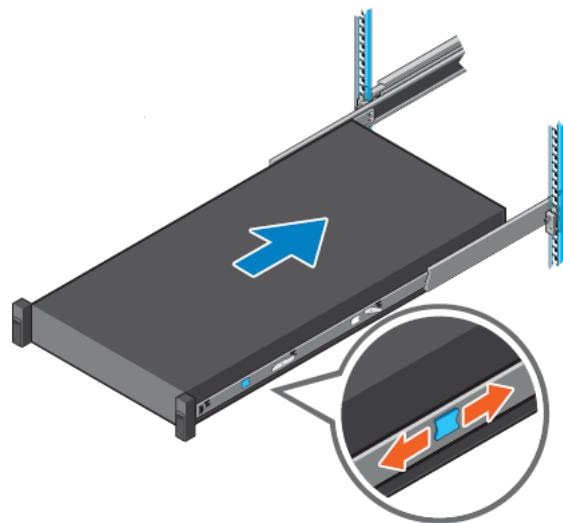

Figure 45. Slide system into the rack

Installing the system into the rack (option B: Stab-In)

1. Pull the intermediate rails out of the rack until they lock into place.
2. Release the inner rail lock by pulling forward on the white tabs and sliding the inner rail out of the intermediate rails.

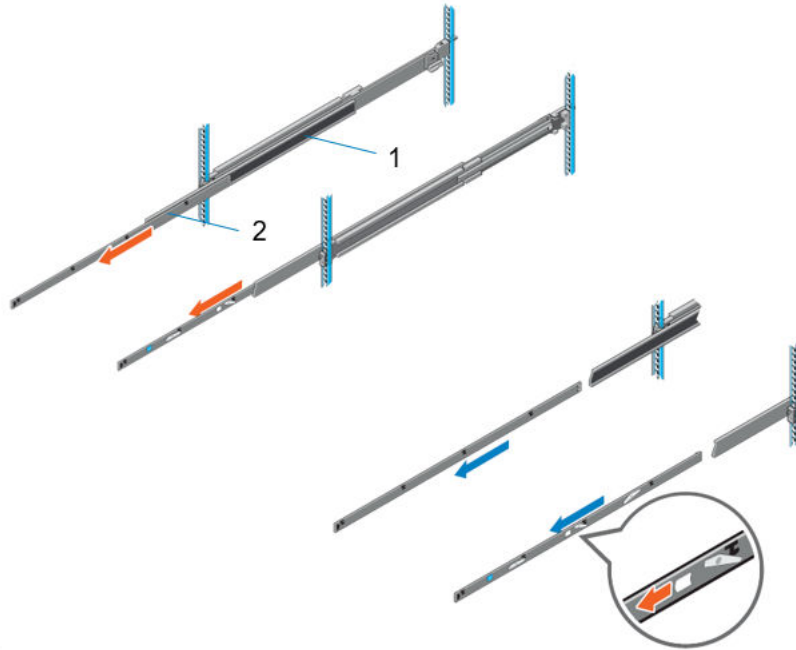

Figure 46. Pull out the intermediate rail

Table 40. Rail component label

Number	Component
1	Intermediate rail
2	Inner rail

3. Attach the inner rails to the sides of the system by aligning the J-slots on the rail with the standoffs on the system and sliding forward on the system until they lock into place.

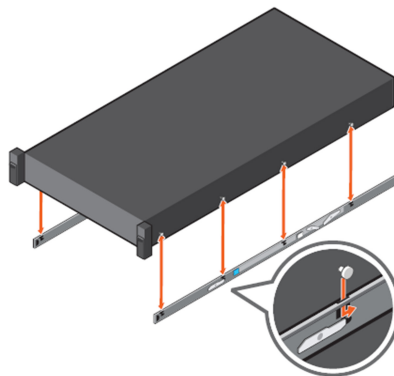

Figure 47. Attach the inner rails to the system

4. With the intermediate rails extended, install the system into the extended rails.

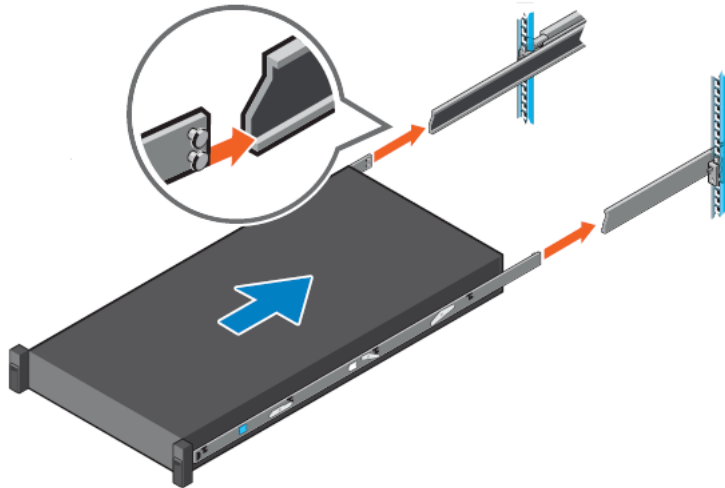

Figure 48. Install system into the extended rails

5. Pull blue slide release lock tabs forward or backward on both rails, and slide the system into the rack.

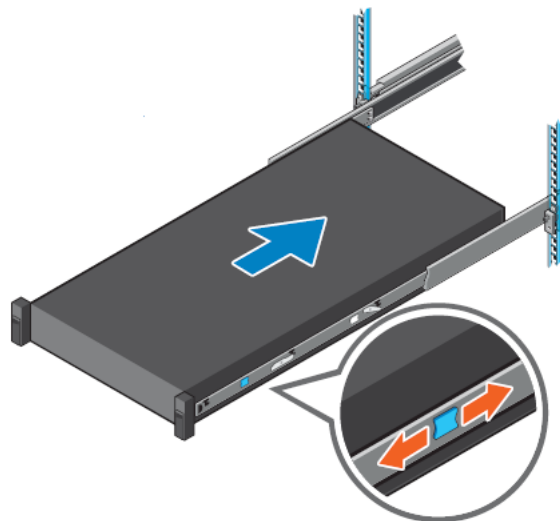

Figure 49. Slide system into the rack

Cable management arm (CMA)

The optional cable management arm (CMA) organizes and secures the cords and cables exiting the back of the systems. It unfolds to allow the systems to extend out of the rack without having to detach the cables. Some key features of the CMA include:

- Large U-shaped baskets to support dense cable loads.
- Open vent pattern for optimal airflow.
- Ability to mount on either side by swinging the spring-loaded brackets from one side to the other.
- Utilizes hook-and-loop straps rather than plastic tie wraps to eliminate the risk of cable damage during cycling.
- Includes a low-profile fixed tray to both support and retain the CMA in its fully closed position.
- Both the CMA and the tray mount without the use of tools by simple and intuitive snap-in designs.

The CMA can be mounted to either side of the sliding rails without the use of tools or the need for conversion. For systems with one power supply unit (PSU), it is recommended to mount on the side opposite to that of the power supply to allow easier access to it and the rear drives (if applicable) for service or replacement.

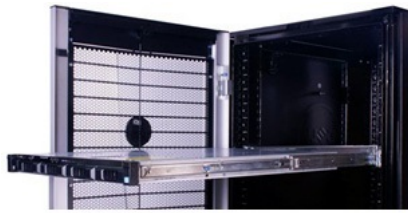

Figure 50. Sliding rails with CMA

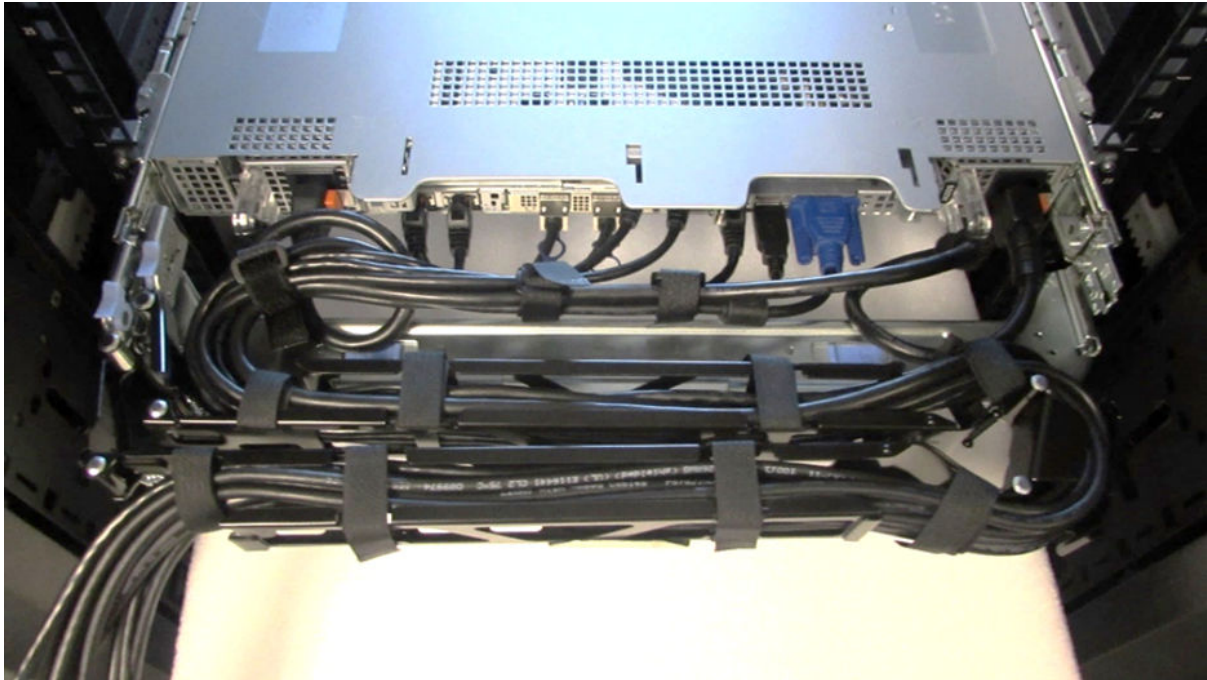

Figure 51. CMA Cabling

Strain Relief Bar (SRB)

The optional strain relief bar (SRB) for the PowerEdge R570 organizes and supports cable connections at the rear end of the server to avoid damage from bending.

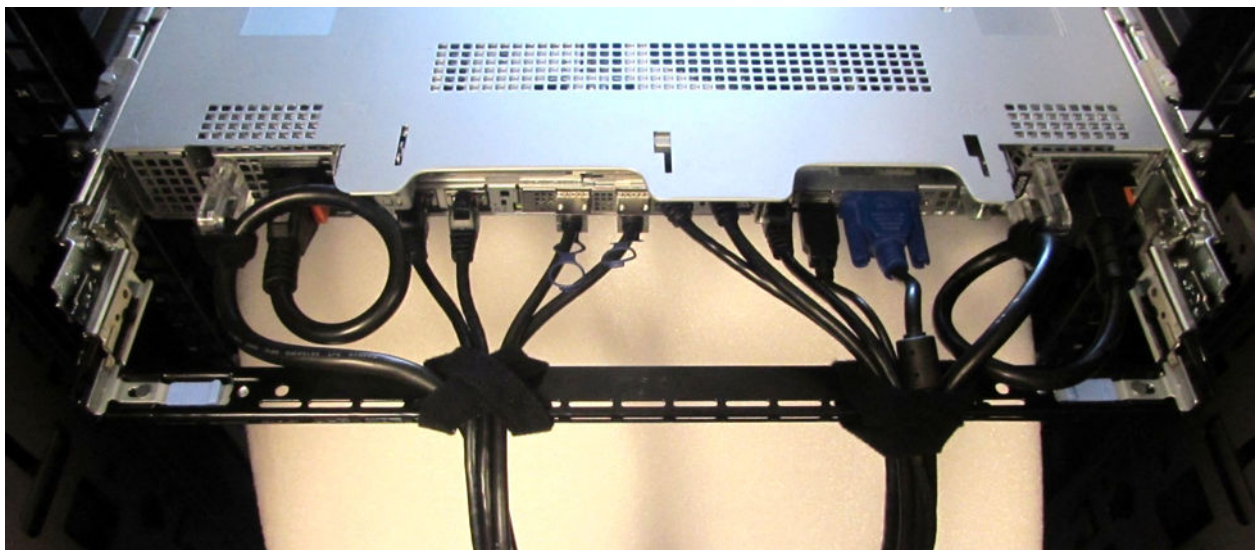

Figure 52. Cabled strain relief bar

- Tool-less attachment to the rails
- Two depth positions to accommodate various cable loads and rack depths
- Supports cable loads and controls stresses on server connectors
- Cables can be segregated into discrete purpose-specific bundles

Operating Systems and Virtualization

Topics:

- [Supported operating systems](#)

Supported operating systems

The PowerEdge R570 system supports the following operating systems:

- Canonical Ubuntu Server LTS
- Microsoft Windows Server with Hyper-V
- RedHat Enterprise Linux
- SUSE Linux Enterprise Server
- VMware ESXi

For specifications and interoperability details, see [OS support](#).

Dell Systems Management

Dell delivers management solutions that help IT administrators deploy, update, monitor, and manage IT assets. OpenManage solutions and tools enable you to solve and respond to problems quickly by manage Dell servers efficiently in physical and remote environments, and operating in-band and out-of-band (agent-free).

The OpenManage portfolio includes innovative embedded management tools such as the integrated Dell Remote Access Controller (iDRAC) and consoles like OpenManage Enterprise, OpenManage Power Manager Plugin, and tools like Repository Manager. Dell has developed comprehensive systems management solutions that are based on open standards by connecting and/or integrating it's offers with top system management vendors and frameworks such as Ansible, Microsoft, and VMware, enabling advanced management of Dell hardware. The key tools for managing Dell PowerEdge servers are iDRAC and OpenManage Enterprise (OME) console. OpenManage Enterprise helps the system administrators with the life cycle management of multiple generations of PowerEdge servers. OME has additional functions that can be added with plugins like OpenManage Enterprise Services, Update Manager, APEX AIOps Observability (formerly CloudIQ), and Power Manager. It also offers integration with VMware vCenter and Microsoft System Center, and a set of tools, including Repository Manager, enabling easy management of PowerEdge hardware. The four main pillars of Dell systems management closely align with the issues and business challenges that are faced by many IT departments.

- Automating IT management.
 - Comprehensive automation management for reducing OPEX and increasing uptime and overall efficiency of systems.
 - Comprehensive suite of tools to automate according to your needs.
- Management made simple.
 - Simple but powerful tools for managing your Dell servers.
 - Integrated tools that streamline support engagements.
 - Innovative at-the-box management features.
- Secure by default.
 - Dell servers offer robust security defenses to prevent the next generation of malicious attacks.
 - Security is designed deep into the hardware and firmware architecture for optimal protection.
- Smarter infrastructure management.
 - It offers a next-generation 1-to-many console to manage your IT and server infrastructure.
 - Embedded intelligence that is infrastructure-aware to optimize troubleshooting and deployment.

This document provides an overview of the OpenManage Systems Management offerings to help IT administrators choose the appropriate tools to completely manage Dell PowerEdge servers.

- The latest [Dell Systems Management Overview Guide](#).

Topics:

- [Integrated Dell Remote Access Controller \(iDRAC\)](#)
- [Systems Management software support matrix](#)

Integrated Dell Remote Access Controller (iDRAC)

iDRAC10 delivers advanced, agent-free, local and remote server administration. Embedded in every PowerEdge server, iDRAC10 provides a secure means to automate a multitude of common management tasks. Because iDRAC is embedded within every PowerEdge server, there is no additional software to install; plug in power and network cables, and iDRAC is ready to go. Even before installing an operating system (operating system) or hypervisor, IT administrators have a complete set of server management features at their fingertips.

With iDRAC10 in-place across the Dell PowerEdge portfolio, the same IT administration techniques and tools can be applied throughout. This consistent management platform allows scaling of PowerEdge servers as an organization's infrastructure grows. Customers can use the iDRAC RESTful API for the latest in scalable administration methods of PowerEdge servers. With this API, iDRAC enables support for the Redfish standard and enhances it with Dell extensions to optimize at-scale management of PowerEdge servers. By having iDRAC at the core, the entire OpenManage portfolio of Systems Management tools allows every customer to tailor an effective, affordable solution for any size environment.

Zero-Touch Provisioning (ZTP) is embedded in iDRAC. ZTP is an Intelligent Automation Dell's agent-free management. Once a PowerEdge server is connected to power and networking that system can be monitored and fully managed, whether you are standing in front of the server or remotely over a network. With no need for software agents, an IT administrator can:

- Monitor
- Manage
- Update
- Troubleshoot, and remediate Dell servers.

With features like zero-touch deployment and provisioning, and System Lockdown, iDRAC10 is purpose-built to simplify server administration. For those customers whose existing management platform uses in-band management, Dell does provide iDRAC Service Module, a lightweight service that can interact with both iDRAC10 and the host operating system to support legacy management platforms.

When ordered with DHCP enabled from the factory, PowerEdge servers can be automatically configured when they are initially powered up and connected to your network. This process uses profile-based configurations that ensure each server is configured per your specifications. This feature requires an iDRAC Enterprise license.

iDRAC10 offers the following license tiers:

Table 41. iDRAC10 license tiers

License	Description
iDRAC10 Core	<ul style="list-style-type: none"> • Available for all servers. • Core system management features for users who are cost conscious.
iDRAC10 Enterprise	<ul style="list-style-type: none"> • Available as an upsell on all servers. • Includes all features of Core. Also, includes additional automation features and virtual console and security features. • Bundled with Secure Enterprise Key Management (SEKM) and Secure Component Verification (SCV) licenses.
iDRAC10 Datacenter	<ul style="list-style-type: none"> • Available as an upsell on all servers. • Includes all features of Core and Enterprise. • Includes key features such as telemetry streaming and thermal management. • Includes advanced accelerators (GPU and DPU) system management and advanced air and liquid cooling.

For a full list of iDRAC features by license tier, see the **Integrated Dell Remote Access Controller 10 User's Guide** at Dell.com.

For more details on iDRAC10 including white papers and videos, see:

- Support for Integrated Dell Remote Access Controller 10 (iDRAC10) is on the [Knowledge Base](#) page at Dell.com

Systems Management software support matrix

Table 42. Systems Management software support matrix

Feature	Technical Specification
Embedded management	iDRAC
	iDRAC Direct
	iDRAC RESTful API with Redfish
	RACADM CLI
	iDRAC Service Module (iSM)
OpenManage console	OpenManage Enterprise (OME)
	OME Power Manager
	OME Services
	OME Update Manager

Table 42. Systems Management software support matrix (continued)

Feature	Technical Specification
	OME APEX AIOps Observability
	OME Integration for VMware vCenter (with VMware Aria Operations)
	OME Integration for Microsoft System Center
	OpenManage Integration for Windows Admin Center
Mobility	OME Mobile w/ Quick Sync 2 wireless module
Tools	IPMI
Change Management	Dell Repository Manager
	Dell System Update
	Enterprise Catalogs
	Server Update Utility (SUU)
OpenManage Integrations	RedHat Ansible Collections
	Terraform Providers
Security	Cryptographically signed firmware
	Data at Rest Encryption (SEDs with local or external key mgmt)
	Secure Boot
	Secured Component Verification (Hardware integrity check)
	Secure Erase
	Silicon Root of Trust
	System Lockdown
	TPM 2.0 FIPS, CC-TCG certified
	Chassis Intrusion Detection
Operating Systems	Canonical Ubuntu Server LTS
	Microsoft Windows Server with Hyper-V
	RedHat Enterprise Linux
	SUSE Linux Enterprise Server
	VMware ESXi

Appendix A: Additional specifications

Topics:

- Chassis dimensions
- System weight
- NIC port specifications
- DPU Specifications
- Video specifications
- USB Ports
- PSU rating
- Environmental specifications

Chassis dimensions

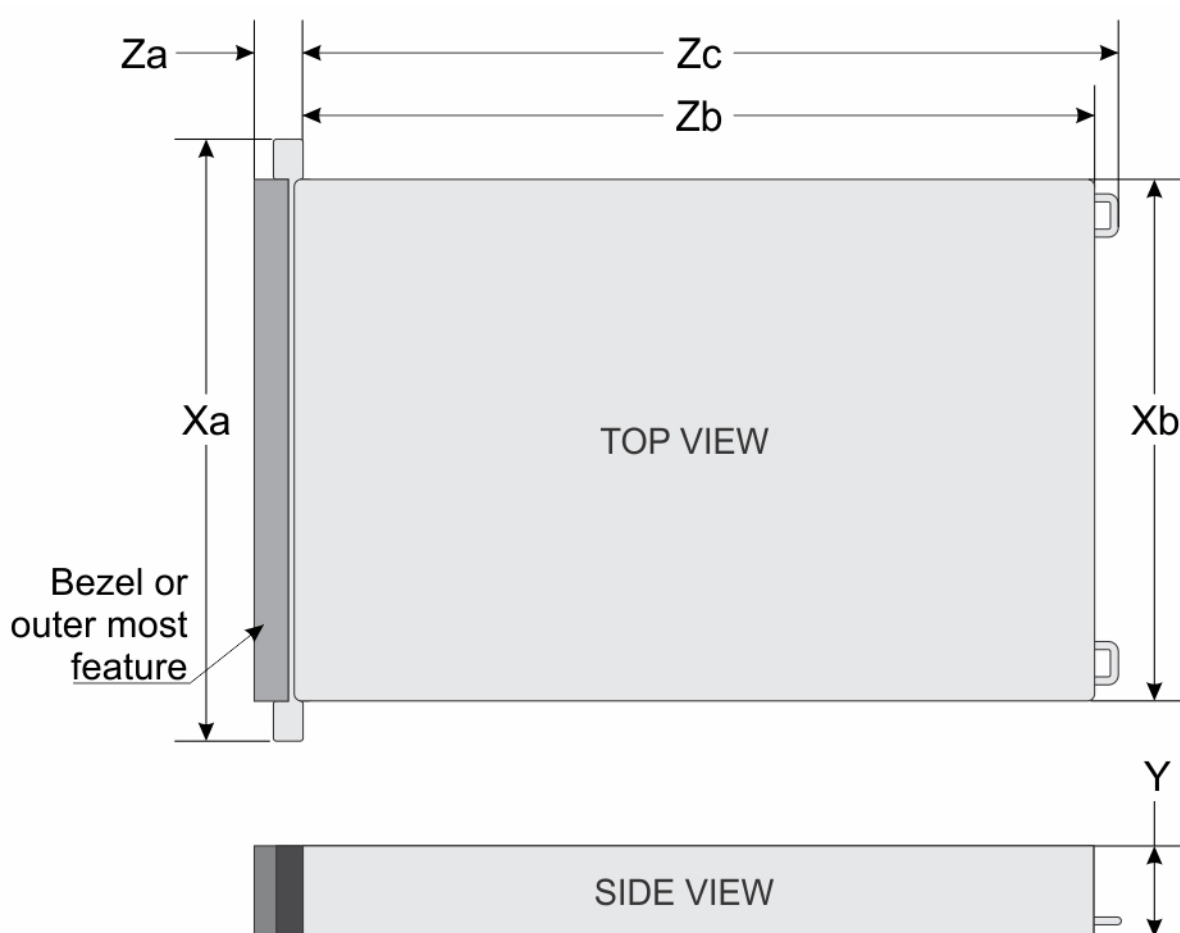

Figure 53. Chassis dimensions

Table 43. PowerEdge R570 chassis dimensions

Drives	Xa	Xb	Y	Za	Zb	Zc
8 x EDSFF E3.S drives 16 x EDSFF E3.S drives Cold aisle configurations	482 mm (19.0 inches)	434 mm (17.1 inches)	86.8 mm (3.42 inches)	42.9 mm (1.69 inches) without bezel i NOTE: Front bezel is not supported in a front I/O configuration.	700.7 mm (27.59 inches) Ear to rear wall	771.6 mm (30.4 inches)
12 x 3.5-inch drives 8 x 2.5-inch drives 16 x 2.5-inch drives 24 x 2.5-inch drives 32 x EDSFF E3.S drives	482 mm (19.0 inches)	434 mm (17.1 inches)	86.8 mm (3.42 inches)	30.78 mm (1.21 inches) with bezel 29.89 mm (1.18 inches) without bezel	700.7 mm (27.59 inches) Ear to rear wall	771.6 mm (30.4 inches)

i **NOTE:** Zb is the nominal rear wall external surface where the HPM board I/O connectors reside.

System weight

Table 44. PowerEdge R570 system weight

System configuration	Maximum weight (with all drives/SSDs)
8 x 2.5-inch SATA (HDD/SSD)	25.2 kg (55.5 lb)
16 x 2.5-inch SATA (HDD/SSD)	27.1 kg (59.7 lb)
24 x 2.5-inch SATA (HDD/SSD)	28.6 kg (63.05 lb)
12 x 3.5-inch SATA (HDD/SDD)	31 kg (68.3 lb)
8 x EDSFF E3.S Gen5 NVMe cold aisle configuration.	27.8 kg (61.28 lb)
8 x EDSFF E3.S Gen5 NVMe cold aisle configuration	22.3 kg (49.16 lb)
16 x EDSFF E3.S Gen5 NVMe cold aisle configuration	22.9 kg (50.48 lb)
32 x EDSFF E3.S Gen5 NVMe hot aisle configuration	24.2 kg (53.35 lb)

Table 45. PowerEdge R570 weight handling recommendations

Chassis weight	Description
40–70 lbs	Recommend two people to lift.
70–120 lbs	Recommend three people to lift.
≥ 121 lbs	Recommend to use a server-lift.

NIC port specifications

The PowerEdge R570 system supports Network Interface Controller (NIC) ports that are embedded on the Open Compute Project (OCP) NIC cards.

Table 46. NIC port specification for the system

Feature	Specifications
OCP NIC 3.0 card	100 GbE x 2, 25 GbE x 2, 25 GbE x 4, 10 GbE x 2, 10 GbE x 4, 1 GbE x 4

NOTE: Up to two OCP NIC cards can be installed in the front or rear of the system, depending on the system I/O configuration.

DPU Specifications

The PowerEdge R470 platform accommodates Data Processing Units (DPUs). These units are system-on-chip solutions that combine ARM cores, high-performance NICs, and programmable acceleration engines to offload and accelerate data center infrastructure services.

Table 47. Supported Data Processing Units(DPU) Cards

Feature	Specifications
Model	NVIDIA BlueField-3 B3220
Type	Data Processing Units (DPU)
Networking	2 x 200 GbE
Form Factor	FHHL
Interface	PCIe Gen5 x16
Power Consumption	150 W
Compatible Risers	RC 1(Slot 7), RC 3(Slot 31), RC 4(Slot 31), RC 5(Slot 7), RC 6(Slot 7), RC 8(Slot 7), RC 9(Slot 7), RC 10(Slot 7), RC 11(Slot 7)

Video specifications

The PowerEdge R570 system supports integrated Matrox G200 graphics controller with 16 MB of video frame buffer.

Table 48. Supported video resolution options

Resolution	Refresh rate (Hz)	Color depth (bits)
640 x 480	60	8, 16, 32
800 x 600	60	8, 16, 32
1024 x 768	60	8, 16, 32
1152 x 864	60	8, 16, 32
1280 x 800	60	8, 16, 32
1280 x 1024	60	8, 16, 32
1360 x 768	60	8, 16, 32
1400 x 1050	60	8, 16, 32
1440 x 900	60	8, 16, 32
1600 x 1200	60	8, 16, 32
1680 x 1050	60	8, 16, 32
1920 x 1080	60	8, 16, 32

Table 48. Supported video resolution options (continued)

Resolution	Refresh rate (Hz)	Color depth (bits)
1920 x 1200	60	8, 16, 32

USB Ports



Figure 54. Front USB Port

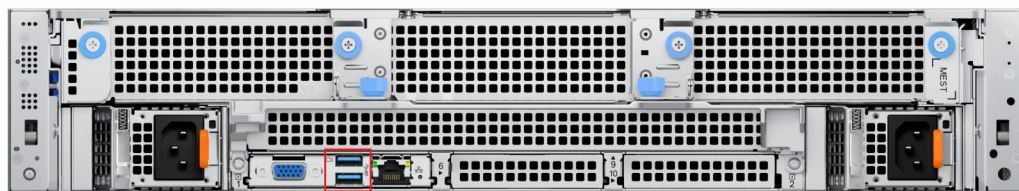

Figure 55. Rear USB Port

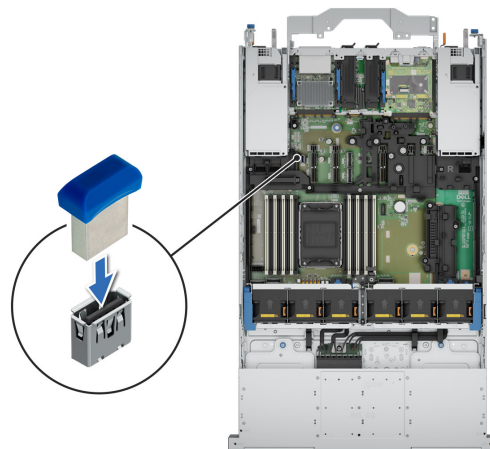

Figure 56. Internal USB Port

Table 49. Systems USB Specifications

Front		Rear		Internal	
USB port type	No. of ports	USB port type	No. of ports	USB port type	No. of ports
USB 2.0 Type C port	1	USB 3.1 Type A ports	2	USB 3.1 Type A port.	1
USB 2.0 Type A port (optional)	1				

PSU rating

Below table lists the power capacity of the PSUs in high/low line operation mode.

Table 50. PSUs highline and lowline ratings

PSU	800 W Platinum	800 W Titanium	1100 W Titanium	1100 W Platinum	1400 w Titanium -48v DC	1500 W Titanium	1500 W Titanium 277v	1800 W Titanium
Peak Power (Highline)	1240 W	1240 W	1705 W	1705 W	N/A	2325 W	2325 W	2790 W
Highline	800 W	800 W	1100 W	1100 W	N/A	1500 W	1500 W	1800 W
Peak Power (Lowline)	1240 W	1240 W	1627 W	1627 W	N/A	1627 W	N/A	N/A
Lowline	800 W	800 W	1050 W	1050 W	N/A	1050 W	N/A	N/A
Highline 240 VDC	800 W	800 W	1100 W	1100 W	N/A	1500 W	N/A	1800 W
Highline 380 VDC	N/A	N/A	N/A	N/A	N/A	N/A	1500 W	N/A
DC-(48—60) V	N/A	N/A	N/A	N/A	1400 W	N/A	N/A	N/A

The PowerEdge R570 supports up to two AC power supplies with 1+1 redundancy, autosensing, and auto switching capability.

If two PSUs are present during POST, a comparison is made between the wattage capacities of the PSUs. In case the PSU wattages do not match, the larger of the two PSUs is enabled. Also, there is a PSU mismatch warning that is displayed in the BIOS or iDRAC.

If a second PSU is added at run-time, in order for that particular PSU to be enabled, the wattage capacity of the first PSU must equal the second PSU. Otherwise, the PSU is flagged as unmatched in iDRAC and the second PSU is not enabled.

Dell PSUs have achieved Platinum and Titanium efficiency levels as shown in the table below.

Table 51. PSU efficiency level

Efficiency Targets by Load						
Form factor	Output	Class	10%	20%	50%	100%
Redundant 60 mm	800 W Mixed mode	Platinum	N/A	90.00%	94.00%	91.00%
	800 W Mixed mode	Titanium	N/A	90.00%	94.00%	91.00%
	1100 W Mixed mode	Titanium	90.00%	94.00%	96.00%	91.00%
	1100 W Mixed mode	Platinum	90.00%	94.00%	96.00%	91.00%
	1400w Titanium -48v DC	Titanium	90.00%	94.00%	96.00%	91.00%
	1500 W Mixed mode	Titanium	90.00%	94.00%	96.00%	91.00%
	1500 W 227v	Titanium	90.00%	94.00%	96.00%	91.00%
	1800 W Mixed mode	Titanium	90.00%	94.00%	96.00%	91.00%

Environmental specifications

NOTE: For additional information about environmental certifications, refer to the **Product Environmental Datasheet** located with the **Manuals & Documents** on [Dell Support](#).

Table 52. Continuous Operation Specifications for ASHRAE A3

Temperature	Allowable continuous operations
Temperature range for altitudes <= 900 m (<= 2953 ft)	5–40°C (41–104°F) with no direct sunlight on the equipment
Humidity percent range (non-condensing at all times)	8% RH with -12°C minimum dew point to 85% RH with 24°C (75.2°F) maximum dew point
Operational altitude de-rating	Maximum temperature is reduced by 1°C/175 m (33.8°F/574 Ft) above 900 m (2953 Ft)

Table 53. Continuous Operation Specifications for ASHRAE A4

Temperature	Allowable continuous operations
Temperature range for altitudes <= 900 m (<= 2953 ft)	5–45°C (41–113°F) with no direct sunlight on the equipment
Humidity percent range (non-condensing at all times)	8% RH with -12°C minimum dew point to 90% RH with 24°C (75.2°F) maximum dew point
Operational altitude de-rating	Maximum temperature is reduced by 1°C/125 m (33.8°F/410 Ft) above 900 m (2953 Ft)

Table 54. Maximum vibration specifications

Maximum vibration	Specifications
Operating	0.21 G _{rms} at 5 Hz to 350 Hz (all operation orientations)
Storage	1.38 G _{rms} at 10 Hz to 500 Hz for 15 minutes (all six sides tested)

Table 55. Maximum shock pulse specifications

Maximum shock pulse	Specifications
Operating	Six consecutively executed shock pulses in the positive and negative x, y, and z axis of 6 G for up to 11 ms.
Storage	Six consecutively executed shock pulses in the positive and negative x, y, and z axis (one pulse on each side of the system) of 71 G for up to 2 ms.

Particulate and gaseous contamination specifications

The following table defines the limitations that help avoid any equipment damage or failure from particulates and gaseous contamination. If the levels of particulates or gaseous pollution exceed the specified limitations and result in equipment damage or failure, you must rectify the environmental conditions. Remediation of environmental conditions is the responsibility of the customer.

Table 56. Particulate contamination specifications

Particulate contamination	Specifications
Air filtration: Conventional Data Center only	Data center air filtration as defined by ISO Class 8 per ISO 14644-1 with a 95% upper confidence limit NOTE: Filtering room air with a MERV8 filter, as specified in ANSI/ASHRAE Standard 127, is a recommended method for achieving the necessary environmental conditions.

Table 56. Particulate contamination specifications (continued)

Particulate contamination	Specifications
	<p>i NOTE: Air entering the data center must have MERV11 or MERV13 filtration.</p> <p>i NOTE: This condition applies to data center environments only. Air filtration requirements do not apply to IT equipment designed to be used outside a data center, in environments such as an office or factory floor.</p>
Walk-Up Edge Data Center or Cabinet (sealed, closed loop environment)	<p>Filtration is not required for cabinets that are anticipated to be opened six times or less per year. Class 8 per ISO 1466-1 filtration as defined above is required otherwise.</p> <p>i NOTE: In environments commonly above ISA-71 Class G1 or that may have known challenges, special filters may be required.</p>
Conductive dust: data center and non-data center environments	<p>Air must be free of conductive dust, zinc whiskers, or other conductive particles.</p> <p>i NOTE: Conductive dust, which can interfere with equipment operation, can originate from various sources, including manufacturing processes and zinc whiskers that may develop on the plating of raised floor tiles.</p> <p>i NOTE: This condition applies to data center and non-data center environments.</p>
Corrosive dust: data center and non-data center environments	<ul style="list-style-type: none"> • Air must be free of corrosive dust. • Residual dust present in the air must have a deliquescent point less than 60% relative humidity. <p>i NOTE: This condition applies to data center and non-data center environments.</p>

Table 57. Gaseous contamination specifications

Gaseous contamination	Specifications	Notes
Copper coupon corrosion rate	ISA-71 Class G1: <300 Å/month	Per ANSI/ISA71.04
Silver coupon corrosion rate	ISA-71 Class G1: <200 Å/month	Per ANSI/ISA71.04

Thermal restriction matrix

Table 58. Label reference

Label	Description
STD	Standard
HPR	High performance
HPR Silver	High performance (HPR) Silver fan
HPR Gold	High Performance (HPR) Gold fan
HSK	Heat sink
LP	Low profile
FH	Full height
EXT	Extended

Table 59. Processor and heat sink matrix

Heat sink	Processor TDP
2U STD HSK	<ul style="list-style-type: none"> Require a regular shroud CPU TDP ≤150 W in Non 12x3.5" configuration
HPR HSK	<ul style="list-style-type: none"> Require a regular shroud CPU TDP > 150 W or all CPUs in 12x3.5" configuration

NOTE: The configuration's ambient temperature is dictated by its critical component. For example, if the processor's ambient temperature is 35°C, the DIMM is 35°C, and the GPU is 30°C, the configuration's ambient temperature can only be 30°C.

Table 60. Thermal restriction matrix for air cooling (non - GPU)

Configuration	Cold Aisle 8 x E3.S 16 x E3.S		8 x 2.5-inch NVMe	12 x 3.5-inch SAS/SATA	12 x 3.5-inch SAS/SATA	16 x 2.5-inch drives 24 x 2.5-inch drives	Hot Aisle 8 x E3.S 16 x E3.S	Hot Aisle 32 x E3.S	Ambient temperature
	Rear storage	No rear drives	No rear drives	Rear 4 x E3.S	No rear drives	No rear drives	No rear drives	No rear drives	
Shroud		Regular Shroud							
Processor	TDP/cTDP	Fan/HSK							
6710E	205 W	HPR Silver fan HPR HSK	HPR Silver fan HPR HSK	HPR Gold fan HPR HSK	HPR Gold fan HPR HSK	HPR Silver fan HPR HSK	HPR Silver fan HPR HSK	HPR Gold fan HPR HSK	35°C
6756E	225 W	HPR Silver fan HPR HSK	HPR Silver fan HPR HSK	HPR Gold fan HPR HSK	HPR Gold fan HPR HSK	HPR Silver fan HPR HSK	HPR Silver fan HPR HSK	HPR Gold fan HPR HSK	35°C
6740E/ 6766E/ 6731E/ 6746E	250 W	HPR Silver fan HPR HSK	HPR Silver fan HPR HSK	HPR Gold fan HPR HSK	HPR Gold fan HPR HSK	HPR Silver fan HPR HSK	HPR Silver fan HPR HSK	HPR Gold fan HPR HSK	35°C
6780E	330 W	HPR Silver fan HPR HSK	HPR Silver fan HPR HSK	HPR Gold fan HPR HSK	HPR Gold fan HPR HSK	HPR Silver fan HPR HSK	HPR Silver fan HPR HSK	HPR Gold fan HPR HSK	35°C
6507P/ 6505P/ 6511P	150 W	HPR Silver fan STD HSK	HPR Silver fan STD HSK	HPR Gold fan HPR HSK	HPR Gold fan HPR HSK	HPR Silver fan STD HSK	HPR Silver fan STD HSK	HPR Gold fan STD HSK	35°C
6517P	190 W	HPR Silver fan HPR HSK	HPR Silver fan HPR HSK	HPR Gold fan HPR HSK	HPR Gold fan HPR HSK	HPR Silver fan HPR HSK	HPR Silver fan HPR HSK	HPR Gold fan HPR HSK	35°C
6724P	210 W	HPR Silver fan HPR HSK	HPR Silver fan HPR HSK	HPR Gold fan HPR HSK	HPR Gold fan HPR HSK	HPR Silver fan HPR HSK	HPR Silver fan HPR HSK	HPR Gold fan HPR HSK	35°C

Table 60. Thermal restriction matrix for air cooling (non - GPU) (continued)

Configuration		Cold Aisle 8 x E3.S 16 x E3.S	8 x 2.5- inch NVMe	12 x 3.5- inch SAS/ SATA	12 x 3.5- inch SAS/ SATA	16 x 2.5- inch drives 24 x 2.5- inch drives	Hot Aisle 8 x E3.S 16 x E3.S	Hot Aisle 32 x E3.S	Ambient tempera ture
Rear storage		No rear drives	No rear drives	Rear 4 x E3.S	No rear drives	No rear drives	No rear drives	No rear drives	
Shroud		Regular Shroud							
Process or	TDP/ cTDP	Fan/HSK							
6521P	225 W	HPR Silver fan HPR HSK	HPR Silver fan HPR HSK	HPR Gold fan HPR HSK	HPR Gold fan HPR HSK	HPR Silver fan HPR HSK	HPR Silver fan HPR HSK	HPR Gold fan HPR HSK	35°C
6731P	245 W	HPR Silver fan HPR HSK	HPR Silver fan HPR HSK	HPR Gold fan HPR HSK	HPR Gold fan HPR HSK	HPR Silver fan HPR HSK	HPR Silver fan HPR HSK	HPR Gold fan HPR HSK	35°C
6527P	255 W	HPR Silver fan HPR HSK	HPR Silver fan HPR HSK	HPR Gold fan HPR HSK	HPR Gold fan HPR HSK	HPR Silver fan HPR HSK	HPR Silver fan HPR HSK	HPR Gold fan HPR HSK	35°C
6737P	270 W	HPR Silver fan HPR HSK	HPR Silver fan HPR HSK	HPR Gold fan HPR HSK	HPR Gold fan HPR HSK	HPR Silver fan HPR HSK	HPR Silver fan HPR HSK	HPR Gold fan HPR HSK	35°C
6730P	250 W	HPR Silver fan HPR HSK	HPR Silver fan HPR HSK	HPR Gold fan HPR HSK	HPR Gold fan HPR HSK	HPR Silver fan HPR HSK	HPR Silver fan HPR HSK	HPR Gold fan HPR HSK	35°C
6741P	300 W	HPR Silver fan HPR HSK	HPR Silver fan HPR HSK	HPR Gold fan HPR HSK	HPR Gold fan HPR HSK	HPR Silver fan HPR HSK	HPR Silver fan HPR HSK	HPR Gold fan HPR HSK	35°C
6747P	330 W	HPR Silver fan HPR HSK	HPR Silver fan HPR HSK	HPR Gold fan HPR HSK	HPR Gold fan HPR HSK	HPR Silver fan HPR HSK	HPR Silver fan HPR HSK	HPR Gold fan HPR HSK	35°C
6787P/ 6767P/ 6781P/ 6761P	350 W	HPR Silver fan HPR HSK	HPR Silver fan HPR HSK	HPR Gold fan HPR HSK	HPR Gold fan HPR HSK	HPR Silver fan HPR HSK	HPR Silver fan HPR HSK	HPR Gold fan HPR HSK	35°C
Memory		Ambient Temperature							
16 GB RDIMM		35°C	35°C	35°C	35°C	35°C	35°C	35°C	35°C
32 GB RDIMM		35°C	35°C	35°C	35°C	35°C	35°C	35°C	35°C
64 GB RDIMM		35°C	35°C	35°C	35°C	35°C	35°C	35°C	35°C
96 GB RDIMM		35°C	35°C	35°C	35°C	35°C	35°C	35°C	35°C

Table 60. Thermal restriction matrix for air cooling (non - GPU) (continued)

Configuration		Cold Aisle 8 x E3.S 16 x E3.S	8 x 2.5- inch NVMe	12 x 3.5- inch SAS/ SATA	12 x 3.5- inch SAS/ SATA	16 x 2.5- inch drives 24 x 2.5- inch drives	Hot Aisle 8 x E3.S 16 x E3.S	Hot Aisle 32 x E3.S	Ambient tempera ture
Rear storage		No rear drives	No rear drives	Rear 4 x E3.S	No rear drives	No rear drives	No rear drives	No rear drives	
Shroud		Regular Shroud							
Process or	TDP/ cTDP	Fan/HSK							
128 GB RDIMM		35°C	35°C	35°C	35°C	35°C	35°C	35°C	35°C

Table 61. Thermal restriction matrix for air cooling (GPU)

Configuration		Cold Aisle 8 x E3.S 16 x E3.S	Ambient temperature
Rear storage		No rear drives	
Shroud		GPU Shroud	
Processor	TDP/cTDP	Fan/HSK	
6710E	205 W	HPR Gold fan 1U EXT HSK	35°C
6756E	225 W	HPR Gold fan 1U EXT HSK	35°C
6740E/6766E/6731E/ 6746E	250 W	HPR Gold fan 1U EXT HSK	35°C
6780E	330 W	HPR Gold fan 1U EXT HSK	35°C
6507P/6505P/6511P	150 W	HPR Gold fan 1U EXT HSK	35°C
6517P	190 W	HPR Gold fan 1U EXT HSK	35°C
6724P	210 W	HPR Gold fan 1U EXT HSK	35°C
6521P	225 W	HPR Gold fan 1U EXT HSK	35°C
6731P	245 W	HPR Gold fan	35°C

Table 61. Thermal restriction matrix for air cooling (GPU) (continued)

Configuration		Cold Aisle 8 x E3.S 16 x E3.S	Ambient temperature
Rear storage		No rear drives	
Shroud		GPU Shroud	
Processor	TDP/cTDP	Fan/HSK	
		1U EXT HSK	
6527P	255 W	HPR Gold fan 1U EXT HSK	35°C
6737P	270 W	HPR Gold fan 1U EXT HSK	35°C
6730P	250 W	HPR Gold fan 1U EXT HSK	35°C
6741P	300 W	HPR Gold fan 1U EXT HSK	35°C
6747P	330 W	HPR Gold fan 1U EXT HSK	35°C
6787P/6767P/6781P/ 6761P	350 W	HPR Gold fan 1U EXT HSK	30°C
Memory		Ambient Temperature	
16 GB RDIMM		35°C	35°C
32 GB RDIMM		35°C	35°C
64 GB RDIMM		35°C	35°C
96 GB RDIMM		35°C	35°C
128 GB RDIMM		35°C	35°C

Appendix B. Standards compliance

The system conforms to the following industry standards.

Table 62. Industry standard documents

Standard	URL for information and specifications
ACPI Advance Configuration and Power Interface Specification, v6.4	ACPI
Ethernet IEEE Std 802.3-2022	IEEE Standards
MSFT WHQL Microsoft Windows Hardware Quality Labs	Windows Hardware Compatibility Program
IPMI Intelligent Platform Management Interface, v2.0	IPMI
DDR5 Memory DDR5 SDRAM Specification	DDR5 SDRAM
PCI Express PCI Express Base Specification, v5.0	PCIe specifications
PMBus Power System Management Protocol Specification, v1.2	PMBus specifications
SMBIOS System Management BIOS Reference Specification, v3.3.0	DMTF SMBIOS
TPM Trusted Platform Module Specification, v2.0	TPM specifications
UEFI Unified Extensible Firmware Interface Specification, v2.7	UEFI specifications
PI Platform Initialization Specification, v1.7	
USB Universal Serial Bus v2.0 and SuperSpeed v3.0 (USB 3.1 Gen1)	USB document library
NVMe Express Base Specification. Revision 2.0c	NVMe specifications
NVMe Command Set Specifications	
1. NVMe Express NVMe Command Set Specification. Revision 1.1c	
2. NVMe Express Zoned Namespaces Command Set. Revision 1.0c	
3. NVMe Express® Key Value Command Set. Revision 1.0c	
NVMe Transport Specifications	
1. NVMe Express over PCIe Transport. Revision 1.0c	
2. NVMe Express RDMA Transport Revision. 1.0b	
3. NVMe Express TCP Transport. Revision 1.0c	
NVMe NVMe Express Management Interface. Revision 1.2c	
NVMe NVMe Boot Specification. Revision 1.0	

Appendix C: Additional resources

Table 63. Additional resources

Resource	Description of contents	Location
Installation and Service Manual	<p>This manual, available in PDF format, provides the following information:</p> <ul style="list-style-type: none"> • Chassis features • System Setup program • System indicator codes • System BIOS • Remove and replace procedures • Diagnostics • Jumpers and connectors 	Dell.com/Support/Manuals
Getting Started Guide	<p>This guide ships with the system, and is also available in PDF format. This guide provides the following information:</p> <ul style="list-style-type: none"> • Initial setup steps 	Dell.com/Support/Manuals
Rack Installation Guide	<p>This document ships with the rack kits, and provides instructions for installing a server in a rack.</p>	Dell.com/Support/Manuals
System Information Label	<p>The system information label documents the HPM board layout and system jumper settings. Text is minimized due to space limitations and translation considerations. The label size is standardized across platforms.</p>	Inside the system chassis cover
MyDell label	<p>This code on the chassis can be scanned by a phone application to access additional information and resources for the server, including videos, reference materials, service tag information, and Dell contact information.</p>	Inside the system chassis cover
Enterprise Infrastructure Planning Tool (EIPT)	<p>The Dell online EIPT enables easier and more meaningful estimates to help you determine the most efficient configuration possible. Use EIPT to calculate the power consumption of your hardware, power infrastructure, and storage.</p>	Dell.com/calc

Appendix D: Service and support

Topics:

- [Why attach service contracts](#)
- [ProSupport Infrastructure Suite](#)
- [Specialty Support Services](#)
- [ProDeploy Infrastructure Suite](#)
- [Supplemental Deployment Services](#)
- [Unique Deployment Scenarios](#)
- [DAY 2 – Automation Services with Ansible](#)
- [Dell Technologies Consulting Services](#)

Why attach service contracts

Dell PowerEdge servers include a standard hardware warranty that highlights our commitment to product quality by guaranteeing repair or replacement of defective components. While industry-leading, our warranties are limited to 1 or 3 years, depending on model, and do not cover software assistance. Call records show that customers are most often seeking Dell technical support for software related issues like configuration guidance, troubleshooting, upgrade assistance or performance tuning. Encourage customers to purchase ProSupport service contracts to supplement warranty coverage and ensure optimal support for both hardware and software. ProSupport provides a complete hardware guarantee beyond the original warranty period.

ProSupport Infrastructure Suite

ProSupport Infrastructure Suite is a set of support services that enable customers to build the solution that is right for their organization. It is an industry-leading, enterprise-class support that aligns with the criticality of your systems, the complexity of your environment, and the allocation of your IT resources.

Figure 57. ProSupport Enterprise Suite

	Basic Hardware Support ¹	ProSupport	BEST ProSupport Plus
Outcome Assistance and Advocacy via assigned Technical Customer Success Manager ⓘ			
Enjoy a frictionless customer experience with cross-functional lifecycle management aligned to your goals			✓
Accelerate time-to-value through onboarding assistance, education and success planning			✓
Turn challenges into opportunities with actionable strategies powered by data and AI-driven analytics			✓
Ensure coverage continuity while preparing to scale for future success			✓
Proactive Monitoring & Actionable Insights via Dell's connectivity solutions and tools			
Quickly visualize performance through a current system health score		✓	✓
Cybersecurity monitoring and mitigation recommendations provide another layer of protection		✓	✓
Predictive performance and capacity analysis address bottlenecks		✓	✓
Prevent or plan for downtime with predictive hardware anomaly detection		✓	✓
Energy consumption and carbon footprint forecasting support sustainability and stewardship initiatives		✓	✓
Get ahead of problems with proactive issue detection with automated case creation	✓	✓	✓
Streamline internal IT efforts with efficient service request and escalation management tools	✓	✓	✓
Minimize disruptions by self-dispatching eligible parts	✓	✓	✓
Support Essentials			
Receive an assigned incident manager for Sev 1 issues who will work your issue through to resolution		✓	✓
Count on Mission Critical Support during Sev 1 incidents and natural disasters ⓘ			✓
Keep systems code current and performing at peak through Proactive System Maintenance			✓
Get priority access to senior technical support engineers—skip the queues and callbacks			✓
Bringing your own software? We provide limited 3rd party software support ⓘ			✓
Choose onsite parts delivery and labor response that meets your needs	Next Business Day	NBD or 4-hour	4-hour
Select product coverage that best augments your internal resources	Hardware	Hardware & Software	Hardware & Software
Have an issue? We are here for you by phone, chat and online	Local business hours	24/7/365	24/7/365

ProSupport Plus for Infrastructure

ProSupport Plus for Infrastructure is the ultimate solution for customers seeking preventative maintenance and optimal performance on their business-critical assets. The service caters to customers who require proactive, predictive, and personalized support for systems that manage critical business applications and workloads. When customers purchase PowerEdge server, we recommend ProSupport Plus, our proactive and preventative support service for business-critical systems. ProSupport Plus provides all the benefits of ProSupport, including the following “Top five reasons to buy ProSupport Plus (PSP)”

- 1. Priority access to specialized support experts:** Immediate advanced troubleshooting from an engineer that understands Dell infrastructure solutions.
- 2. Mission Critical Support:** When critical (Severity 1) support issues happen, the customer is assured that we do all that we can to get them back up and running as quickly as possible.
- 3. Technical Customer Success Manager:** A customer’s #1 support advocate, ensuring they get the best possible proactive and predictive support experience.
- 4. Systems maintenance:** On a semiannual basis, we will keep a customer’s ProSupport Plus system(s) up to date by installing the latest firmware, BIOS, and driver updates to improve performance and availability.
- 5. Third-party software support:** Dell is a customer’s single point of accountability for any eligible third-party software that is installed on their ProSupport Plus system, whether they purchased the software from us or not.

ProSupport for Infrastructure

Comprehensive 24x7 support for hardware and software – best for production, but not critical, workloads and applications. The ProSupport service offers highly trained experts around the clock and around the globe to address IT needs. We help minimize disruptions and maximize availability of PowerEdge server workloads with:

- 24x7 support through phone, chat and online
- A central point of accountability for all hardware and software issues
- Hypervisor, operating system, and application support
- Dell security advisories

- Onsite response service levels 4 hour or Next Business Day options
- Proactive issue detection with automated case creation
- Predictive hardware anomaly detection
- Incident Manager assigned for Severity 1 cases
- Collaborative third-party support
- Access to AIOps Platforms - (MyService360, TechDirect, and CloudIQ)
- Consistent experience regardless of where customers are located or what language that they speak.

Basic Hardware Support

Provides reactive hardware support during normal business hours, excluding local national holidays. No software support or software-related guidance. For improved levels of support, choose ProSupport or ProSupport Plus.

Specialty Support Services

Optional specialty support services complement the ProSupport Infrastructure Suite to provide additional proficiencies that are critical for modern data center operations.

Hardware coverage add-ons to ProSupport or ProSupport Plus

- **Keep Your Hard Drive (KYHD), Keep Your Component (KYC), or Keep Your GPU (KYGPU):**

Normally if a device fails under warranty, Dell replaces it using a one-for-one exchange process. KYHD/KYCC/KYGPU gives you the option to retain your device. It provides full control of sensitive data and minimizes security risk by letting you retain possession of failed drives, components, or GPU when receiving replacement parts without incurring additional cost.

- **Onsite Diagnosis Service:**

Ideal for sites with non-technical staff. Dell field technician performs initial troubleshooting diagnosis onsite and transfers to Dell remote engineers to resolve the issue.

- **ProSupport Add-on for HPC:**

Sold as an add-on to a ProSupport service contract, the ProSupport Add-on for HPC provides solution-aware support to cover the additional requirements that are required to maintain an HPC environment such as:

- Access to senior HPC experts
- Advanced HPC cluster assistance: Performance, interoperability, and configuration
- Enhanced HPC solution level end-to-end support
- Remote pre-support engagement with HPC Specialists during ProDeploy implementation

- **ProSupport Add-on for Telco (Respond & Restore):**

An add-on service designed for the top 31 TELCO customers globally, Respond & Restore provides direct access to Dell solution experts who specialize in TELCO carrier-grade support. This add-on also provides a hardware uptime guarantee, meaning if a system fails, Dell has it installed and operational within 4 hours for Severity 1 issues. Dell incurs penalties and fees if SLAs are not met.

Personalized Support and Supplemental Site-wide Expertise

- **Technical Account Manager:**

Designated technology lead who monitors and manages the performance and configuration of specific technology sets.

- **Designated Remote Support:**

Personalized support expert who manages all troubleshooting and resolution of IT assets.

- **Multivendor Support Service:**

Support your third-party devices as one service plan for servers, storage, and networking (includes coverage for: Broadcom, Cisco, Fujitsu, HPE, Hitachi, Huawei, IBM, Lenovo, NetApp, Oracle, Quanta, SuperMicro and others).

Services for large enterprises

- **ProSupport One for Data Center:**

ProSupport One for Data Center offers flexible site-wide support for large and distributed data centers with more than 1,000 assets (combined total of server, storage, networking, so forth). This offering is built on standard ProSupport features that leverage our global scale and are tailored to specific customer needs. While not for everyone, this service option offers a truly unique solution for our largest customers with the most complex environments.

- Team of assigned Services Account Managers with remote or onsite options
- Assigned technical and field engineers who are trained on the customer's environment and configurations.
- On-demand reporting and recommendations that are enabled by ProSupport AIOps tools (MyService360, TechDirect, and CloudIQ)
- Flexible onsite support and parts options that fit their operational model
- A tailored support plan and training for their operations staff

- **ProSupport One for Data Center – CSP (Cloud Serviced Provider) and AI Solution**

ProSupport One for Data Center – CSP and AI Solution is a unique offer that is designed for a limited set of Dell accounts purchasing AI computing solutions greater than 1,000 servers and \$250M in sales. PS1DC - CSP and AI improves the entire services experience combining support, deployment (rack integration), residency services, a designated support engineer, an onsite service engineer, and an onsite parts service as one holistic offer. Special pricing has been determined to compete effectively against competitors and provide the best customer experience. PS1DC for CSP and AI can only be sold with XE Servers and all networking platforms (Dell and NVIDIA). All other products would be eligible for the standard PS1DC, not this unique offer. More details on PS1DC for CSP and AI [here](#).

- **Onsite Parts Service (OPS)**

Ideal for large organizations that have their own staff to support their data center. Dell offers a service that is called Onsite Parts Service (OPS) from Dell Services. OPS manages parts inventory located at the customer's designated facility. The Logistics Online Inventory Solution (LOIS) program will use software to support the monitoring and automatic replenishment of inventory stored on the customer site. . Each replacement part would automatically initiate a replenishment of the parts inventory that is shipped the next day or delivered onsite by Dell during a regular scheduled visit (called Scheduled Onsite Service). As part of the LOIS system, customers can integrate their systems directly to Dell TechDirect using APIs to help streamline the support management process.

End-of-Life Services

- **Post Standard Support (PSS)**

Extend service life beyond the initial seven years of ProSupport, adding up to five more additional years of hardware coverage.

- **Data Sanitization & Data Destruction**

Renders data unrecoverable on repurposed or retired products, ensuring security of sensitive data and enabling compliance and provides NIST-compliant certification.

- **Asset Recovery Services**

Recycle, resale, and disposal of hardware. Helps you securely and responsibly retire IT assets that are no longer needed while protecting both your business and the planet.

ProDeploy Infrastructure Suite

ProDeploy Infrastructure Suite provides various deployment offerings that satisfy a customer's unique needs. It is made up of various sub-offers: Factory Configuration Services, Rack Integration, Basic Deployment, ProDeploy, ProDeploy Plus, and optionally ProDeploy FLEX which allows for some customization of the features listed.

ProDeploy Infrastructure Suite

Versatile choices for accelerated deployments

NOTE: All XE Series servers require mandatory deployment

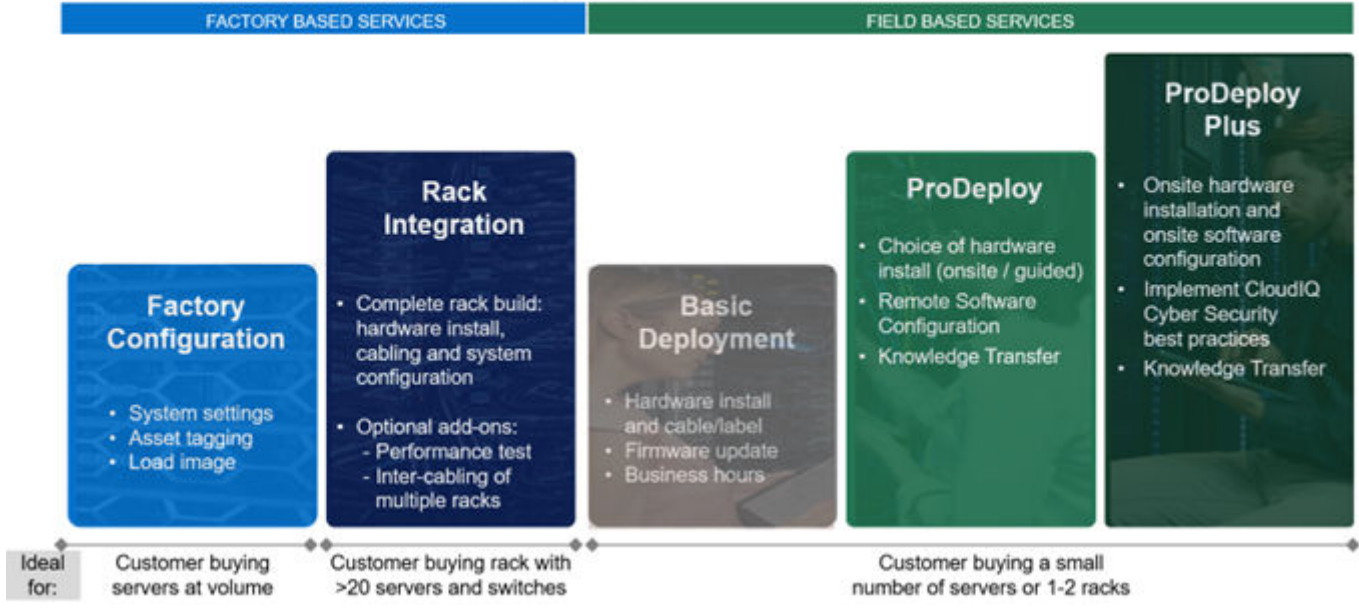

Figure 58. ProDeploy Infrastructure Suite

Factory-based Services

Pre-configured systems or complete racks, customized prior to shipping to the customer's site.

Customer Rack Integration or ProDeploy FLEX Rack Integration

Dell offers robust custom rack integration services through two main programs: Enterprise Rack Integration Services and Integrated Rack Scalable Systems (IRSS). These services are designed to streamline deployment, reduce complexity, and optimize performance for data centers, edge environments, and AI workloads. These factory services are purchased as a custom engagement or as ProDeploy Flex Rack Integration SKUs.

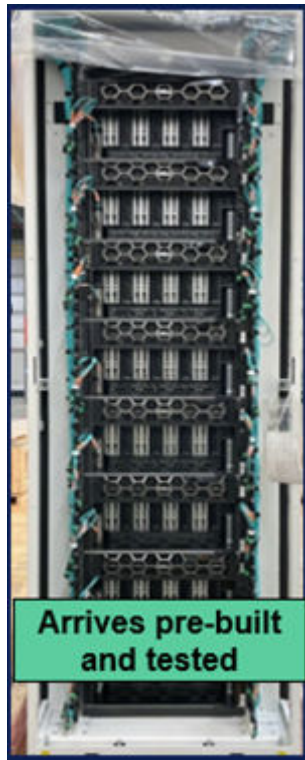

Figure 59. Pre-configured system



Figure 60. Pre-configured system

Factory Configuration

Ideal for customers buying servers in volume and seeking pre-configuration prior to shipping such as: custom image, system settings, and asset tagging so it arrives ready to use out of the box. Furthermore, servers are packaged and bundled to meet specific shipping and distribution requirements for each customer location to facilitate the rollout process. Once the server is onsite, Dell can install and configure the server to the environment using any of the field-based deployment services outlined in the next section.

Field-based services

Put PowerEdge servers to work faster with Dell field-based deployment services. Whether we are deploying one server to one thousand – we have you covered. Dell provides versatile delivery options to fit every budget and operating model.

- **ProDeploy Plus:** Elevate Infrastructure deployments with our most complete service from planning through onsite hardware installation and software configuration including the implementation of cybersecurity best practices. ProDeploy Plus provides the skill and scale that is needed to successfully execute demanding deployments in today's complex IT environments. The deployment starts with a site readiness review and implementation plan. Certified deployment experts perform the software configuration to include setup of leading operating systems and hypervisors. Dell will also configure PowerEdge software tools to include iDRAC and OpenManage system utilities as well as support AI Ops platforms: MyService360, TechDirect, and

CloudIQ. Unique to ProDeploy Plus, the cybersecurity implementation helps customers understand potential security risks and make recommendations for reducing product attack surfaces. The system is tested, validated prior to completion. The customer will also receive full project documentation and knowledge transfer to complete the process.

- **ProDeploy:** ProDeploy provides remote software configuration and choice of hardware installation (onsite or guided). ProDeploy is great for customers who are price sensitive or willing to participate in some portion of the deployment to include providing remote access to their network. The ProDeploy remote software includes everything mentioned in ProDeploy Plus except it does not include the added value, cybersecurity implementation, and implementation best practices.
- **Basic Deployment:** Basic Deployment delivers worry-free professional installation by experienced technicians. This service is often sold to Competency Enabled Partners who will have Dell do the hardware installation while they complete the software configuration. Furthermore, Basic Deployment tends to be purchased by large enterprises who have smart technical staff. These companies just need Dell to install the hardware, and they will perform the software configuration. The last use case for Basic Deployment is when paired with Factory Configuration services. The servers are preconfigured in the factory, and the basic deployment service will install the system into the rack to finalize the deployment.

ProDeploy Infrastructure Suite | Field services

		Basic Deployment	ProDeploy	ProDeploy Plus
Pre-deployment	Single point of contact for project management	-	●	In region
	Site readiness review and implementation planning	-	●	●
Deployment	Deployment service hours	Business hours	24/7	24/7
	Hardware installation options	Onsite	Onsite or guided ¹	Onsite
	System software installation and configuration options	-	Remote	Onsite
	Install connectivity software based on Secure Connect Gateway technology ²	-	●	●
	Implement CyberSecurity best practices and policies in APEX AIOps Infrastructure Observability	-	-	●
Post-deployment	Deployment verification, documentation and knowledge transfer	-	●	●
	Configuration data transfer to Dell technical support	-	●	●
Online collaboration	Online collaborative platform in TechDirect for planning, managing and tracking delivery	-	●	●

¹ Choose from onsite hardware installation or a guided option including project specific instructions, documentation and live expert guidance
² Post deployment use for intelligent, automated support & insights

Figure 61. ProDeploy Infrastructure Suite - Field services

Supplemental Deployment Services

Additional ways to expand scope or deploy for unique scenarios.

Two Host Adder (requires PD/PDP)

Deploying new storage, compute, or networking devices may require interconnection to other servers (also called hosts). The Dell delivery team will set up four hosts per device as part of every ProDeploy service. For example, if the customer is buying two storage arrays the ProDeploy service will automatically include connectivity of four hosts each (4x2=8 total hosts per project since there are two devices). This supplemental "Two Host Adder" service provides for the configuration of additional hosts above what is already provided as part of the ProDeploy service. In many cases, customers can work with us while we set up the included hosts, so they may understand how to do the rest themselves. Always ask the customer how many hosts are being connected and sell the host adder depending on the customer's technology skillset. Note that this service applies to the connectivity of Dell devices not 3rd party devices.

Additional Deployment Services (ADT) – sold with or without PD/PDP

You can expand the scope of a ProDeploy engagement leveraging Additional Deployment Time (ADT). ADT covers additional tasks above the normal deliverables of the ProDeploy offers. ADT can also be used as a standalone service without ProDeploy.

SKUs are available for both Project Management and Technical Resource Expertise. SKUs are sold as blocks of four hours remote or eight hours onsite. The delivery team can help in scoping the number of hours required for additional tasks.

Data Migration Services

Migrating data sets is no easy task. Our experts use proven tools and process to streamline data migrations and avoid compromising data. A customer project manager works with our experienced team of experts to create a migration plan. Data migration is part of every technology upgrade, platform change, and shift to the cloud. You can rely on Dell data migration services to perform a seamless transition.

Residency Services

Certified technical professionals act like an extension of your IT staff to enhance internal capabilities and resources and help you realize faster adoption and maximized ROI of new technology. Residency Services help customers transition to new capabilities quickly by leveraging specific technology skill sets. Residency experts can provide post implementation management and knowledge transfer that is related to a new technology acquisition or day-to-day operational management of the IT infrastructure.

- Global experts available to serve in-person (onsite) or virtual (remote)
- Engagements starting at 2 weeks with flexibility to adjust
- Residency is available for project management needs, and many different technology skills sets such as: Server, storage, Gen AI, networking, security, multi-cloud, data mgmt., and modern workforce application residents

Unique Deployment Scenarios

Custom Deployment Services

When a deployment is beyond the scope of the ProDeploy Infrastructure Suite, you can turn to the custom deployment services team to address complex implementation scenarios and customer unique requirements. The Dell custom deployment team is staffed with solution architects who will assist with customer scoping calls to define the project and develop the statement of work. Custom services can handle a wide range of deployments that can be performed in the factory or onsite. All custom engagement services are requested through SFDC.

Deployment of AI or HPC using Cluster Build Services

Once the integrated rack arrives the data center or is built onsite, Dell can also convert the racks into a large computing cluster. Dell provides several deploy options for Artificial Intelligence (AI) or High-Performance Computing (HPC) implementations. These complex environments require specialists that understand advanced feature sets to create a unified computing cluster for the most demanding workloads. Choose one of the cluster build add-ons below.

Sell as Custom Quote or Standard SKUs
Add-ons 1 & 2 arriving as standard SKUs in Sept.

ProDeploy Flex Rack Integration or ProDeploy Flex Onsite + **Cluster Build Add-ons**
Select one or more add-ons below

		Ideal for
	1 Physical Configuration of Cluster <ul style="list-style-type: none"> Onsite Infrastructure Assessment Installation of switches¹ Inter-rack cabling and labeling Liquid connectivity and leak test² 	Customers needing help with installing the network, inter-rack cabling, and fabric testing
	2 Logical Configuration of Cluster <ul style="list-style-type: none"> Review system design and plan Configure switches & mgmt nodes Validation and acceptance testing 	Customers requiring cluster configuration and essential testing of the solution
	3 AI Network Design Services <ul style="list-style-type: none"> 2-week intensive consultation that accelerates AI network performance and maximizes operational efficiency³ 	Customers seeking foundational design strategy to achieve optimal performance

When the environment is demanding, your configuration can't be average ★★★★★

Key Benefits:

- Factory rack integration enables faster time to value and reliability
- Reduce onsite setup time and fast track to production
- Fine-tuned system performance based on workload types
- Services aligned with enterprise-grade security standards
- Final testing and customer handoff lessen amount of support calls

1 -- Network switches to be installed in factory or onsite depending on requirements. Choose options: ProDeploy Flex Rack Integration or ProDeploy Flex Onsite combined with PD Flex Cluster Add-ons
2 -- If applicable. Leak test performed in factory and again onsite which is limited to in-rack CXK!
Secondary Fluid Network (SFN) design and deployment quoted separately by Vertiv or Mollnar.
3 -- AI Network Design Service is ordered as a Custom Service Engagement via SFDC or SFP

Figure 62. Deployment choices for cluster implementation

DAY 2 – Automation Services with Ansible

Dell solutions are built as “automation ready” with integrated APIs (Application Programming Interfaces) to allow customers to programmatically call actions on the product through code. Although Dell has published Ansible automation use cases, some customers need additional assistance with GitOps. By the end of the service, the customer will have the foundational components required to accelerate automation and understand how the programming works together: Day 1 and Day 2 use case automation scripts (ansible modules), CI/CD tool (Jenkins), and Version control (Git).

Dell Technologies Consulting Services

Our expert consultants help customers transform faster, and quickly achieve business outcomes for the high-value workloads Dell PowerEdge systems can handle. From strategy to full-scale implementation, Dell Technologies Consulting can help determine how to perform IT, workforce, or application transformation. We use prescriptive approaches and proven methodologies that are combined with the portfolio and partner ecosystem of Dell Technologies to help achieve real business outcomes. From multicloud, applications, DevOps, and infrastructure transformations, to business resiliency, data center modernization, analytics, workforce collaboration, and user experiences—we are here to help.

Dell Managed Services

Some customers prefer Dell to manage the complexity and risk of daily IT operations, Dell Managed Services utilizes proactive, AI enabled delivery operations and modern automation to help customers realize desired business outcomes from their infrastructure investments. With these technologies, our experts run, update, and fine-tune customer environments that are aligned with service levels, while providing environment-wide and down-to-the-device visibility. There are two types of managed service offers. First the outsourcing model or CAPEX model where Dell manages the customer owned assets using our people and tools. The second is the as-a-Service model or OPEX model called APEX. In this service, Dell owns all technology and all the management of it. Many customers will have a blend of the two management types depending on the goals of the organization.



Figure 63. Dell Managed Services

Cyber-Security Services

Managed Detection and Response (MDR)

Dell Managed Detection and Response Pro Plus is our fully-managed, 360° security operations solution comprised of our most cutting-edge, preventive and responsive cybersecurity services. MDR Pro Plus was designed with your top security concerns in mind, allowing you to focus on your core business goals while Dell handles your security operations. First, we have Vulnerability Management. With this service, we'll do ongoing scanning of the customer's environment looking for software that needs to be patched. Next is Pen Testing and Attack Simulation Management. This service will continuously validate security controls and policies with automated Breach and Attack Simulation (BAS), because a misconfiguration can lead to an exposure which an attacker can exploit. The service also includes an annual penetration test to determine if a skilled threat actor could exploit pathways leading to critical assets or data. Third, Managed Security Awareness Training. This service will educate the customer's end users so that they don't inadvertently put the customer at risk. If you think about our annual compliance training modules, there is always a security module. This is the same type of thing, but rather than once a year, it will be smaller, bite-size pieces of content delivered throughout the year. Fourth is our Managed Detection and Response service which provides 24x7 threat detection and investigation, analysis of end-to-end activity by threat actors, threat hunting, and quick initiation of cyber incident response when needed. Customers can choose between Secureworks Taegis XDR, CrowdStrike Falcon XDR or Microsoft Defender XDR as the security analytics platform our analysts will use to monitor their environment. All four of these services are delivered by experienced, certified Dell security experts using advanced technology such as the Secureworks Taegis XDR, CrowdStrike Falcon XDR or Microsoft Defender XDR security platforms.

Dell Technologies Education Services

Build the IT skills required to influence the transformational outcomes of the business. Enable talent and empower teams with the right skills to lead and perform transformational strategy that drives competitive advantage. Leverage the training and certification that is required for real transformation.

Dell Technologies Education Services offers PowerEdge server training and certifications that are designed to help customers achieve more from their hardware investment. The curriculum delivers the information and the practical, firsthand skills that their team must confidently install, configure, manage, and troubleshoot Dell servers.

To learn more or register for a class today, see [Education.Dell.com](https://www.dell.com/education).

Resources

[Service for powerEdge](#)